

APPARATUS • PARTS ACCESSORIES

FOR

RADIO SERVICE MEN

AMATEURS

EXPERIMENTERS

SOUND TECHNICIANS

CUSTOM SET BUILDERS

BULLETIN 933
MAY, 1931

GENERAL RADIO COMPANY
OFFICES • LABORATORIES • FACTORY

CAMBRIDGE A, MASSACHUSETTS

PACIFIC COAST WAREHOUSE
274 BRANNAN STREET
SAN FRANCISCO CALIFORNIA

How to Obtain General Radio Apparatus

*The General Radio Company's established policy
of direct distribution brings you every advantage*

INTELLIGENT SERVICE — A competent personnel, as familiar with your problems as it is with the General Radio line, is maintained to see that your order receives intelligent attention.

BETTER DELIVERIES — Complete stocks of all of the standard items described in this bulletin are maintained at the factory in Cambridge, Massachusetts, and at our Pacific Coast Warehouse in San Francisco. Most shipments are made the same day the order is received, seldom later than 24 hours thereafter.

FAIR PRICES — The fact that all list prices are the true net prices means that you pay the same price as anyone else, which explains, incidentally, why jobbers and dealers do not handle General Radio parts and accessories. Our one-price policy brings you added assurance that the low prices of General Radio apparatus have been obtained without sacrificing the quality of the engineering design, workmanship, or materials.



IMPORTANT

We endeavor to ship within 24 hours after receiving your order. Address the office nearest you.

We prepay the transportation charges to any point in the United States or Canada if full payment accompanies your order.

Be sure your order states clearly what you want. As a precaution against errors, include the name and range or size of each item as well as the type number.

GENERAL RADIO COMPANY

Offices + Laboratories + Factory

CAMBRIDGE A, MASSACHUSETTS

Pacific Coast Warehouse: 274 Brannan Street, San Francisco, California

FOREWORD

The General Radio Company was founded in 1915 to manufacture laboratory apparatus. The list of items included, in addition to the more technical ones, such articles as vacuum-tube sockets, rheostats, etc. With the advent of broadcasting these latter articles became in great demand.

Distribution was originally on a direct to the consumer basis. We found it necessary to accede to the changed conditions and raised our prices so that distribution could be through the jobber and dealer channels.

With the development of complete receivers the use of the separate parts became confined largely to the engineer experimenter, either in his professional activities or as a hobby. This class of consumer enjoyed a trade discount because he did not require the services of a retail dealer. In effect, therefore, list prices were fictitious since they were made large enough to permit a discount to engineer buyers.

With the more limited use of radio component parts, jobbers did not always find it economical to carry the full list of items required by the experimenter. This was particularly true with such a complete and diversified line as that of the General Radio Company.

In order that our engineer customers might obtain those items they desired with a minimum of inconvenience, we discontinued the sale of our products through jobbers and dealers on July 1, 1928. Instead, we arranged a plan of prompt shipment on a factory to consumer basis. We carry adequate stocks and maintain an engineering staff at Cambridge to handle technical correspondence.

Prices were all revised downward, so as to give all customers the advantage of a dealer discount. The prices as they now appear in this bulletin are, therefore, strictly net and are not subject to discount.

Unless credit has been established, all shipments are made on a C. O. D. basis. While prices are F. O. B. our factory at Cambridge, Massachusetts, or from our San Francisco, California, warehouse, we prepay transportation charges on United States and Canadian shipments whenever cash accompanies the order.

Prices have been revised to April 1, 1931, but are subject to change without notice. Shipment will, however, not be made at higher prices than those given in an order without further confirmation.

TABLE OF CONTENTS

AIR CONDENSERS	3
VOLUME-CONTROL DEVICES	7
RHEOSTATS AND POTENTIOMETERS	10
EXPERIMENTAL INDUCTORS	14
TUNING-FORK AND MICROPHONE-BUTTON OSCILLATORS	16
COUPLING DEVICES	17
POWER TRANSFORMERS	22
RECTIFIER FILTERS	23
ACCESSORIES	23
AMATEUR FREQUENCY STANDARDS	25
SERVICE-TESTING INSTRUMENTS	27
METERS	33
RELAYS, SWITCHES, AND MISCELLANEOUS ACCESSORIES	44

GENERAL-PURPOSE AIR CONDENSERS

IN this section are listed condensers for radio receiver and transmitter construction and for general experimental use where accurate calibrations are not the first consideration. A variety of models are available with maximum capacitances between 15 μf and 1000 μf ; with straight-line capacitance, wavelength, and frequency plates; and for panel and table mounting.

Dielectric losses are kept low by the use of a small amount of properly placed hard rubber. All plates are of brass. Rotor and stator sections are assembled in jigs and soldered. This makes a rugged mechanical as well as an exceptionally low-resistance electrical assembly.

All condensers using soldered plates are manufactured under U. S. Patent No. 1,542,995. All condensers using plates other than of semicircular shape are manufactured under U. S. Patent No. 1,258,423.

TYPE 247 VARIABLE AIR CONDENSERS

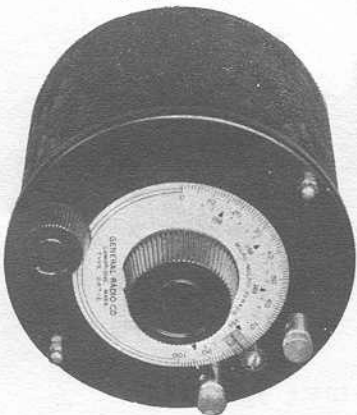

TYPE 247-G

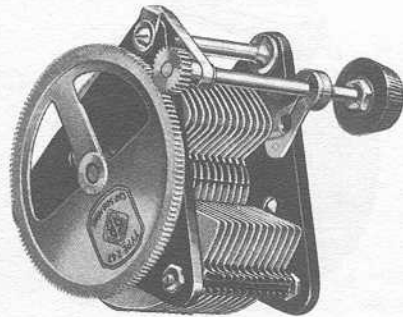

TYPE 247-H

MOUNTED MODELS

THESE condensers have triangular hard-rubber end plates. All models are counter-weighted.

Range: See price list.
Rotor Plates: Straight-line capacitance (semi-circular).

Insulation: Hard-rubber end plates.
Maximum Voltage: 500 volts, peak.

Drive: Modified TYPE 310 Dial. Spur-gear-driven vernier or counterweight as shown in price list.

Depth, see price list.

Type	Capacitance	Max. Min.	Depth	Weight	Code Word	Price
247-E	500 μf	30 μf	4 $\frac{1}{2}$ in.	2 lb.	COUPE	\$5.00
247-G	500 μf	30 μf	4 $\frac{1}{2}$ in.	2 $\frac{1}{8}$ lb.	COLIC	3.75
247-J	250 μf	30 μf	4 $\frac{1}{2}$ in.	1 $\frac{5}{8}$ lb.	CANON	4.50
247-L	250 μf	30 μf	4 $\frac{1}{2}$ in.	2 lb.	CAROM	5.25

(Continued on following page)

UNMOUNTED MODELS

UNMOUNTED models are similar except that panels, cases, and dials are not supplied, and rotor plates are straight-line wavelength.

Rotor Plates: Straight-line wavelength.

Dimensions: Panel space, 4 inches diameter.

Calibration: Supplied without either dials or calibrations.

Type	Capacitance			Depth	Weight	Code Word	Price
	Max.	Min.					
247-F	500 μf	20 μf Counterweight	4½ in.	1⅜ lb.	COCOA	\$3.00
247-H	500 μf	20 μf Gear.....	4½ in.	1⅜ lb.	COMIC	3.75
247-N	350 μf	15 μf Counterweight	4½ in.	1¼ lb.	ABASE	2.75
247-P	350 μf	15 μf Gear.....	4½ in.	¼ lb.	ABBEY	3.50
247-K	250 μf	15 μf Counterweight	4 in.	⅞ lb.	CARGO	2.50
247-M	250 μf	15 μf Gear.....	4 in.	1 lb.	CIGAR	3.25

TYPE 334 VARIABLE AIR CONDENSERS

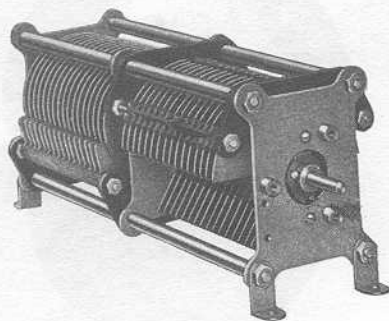

TYPE 334-Z

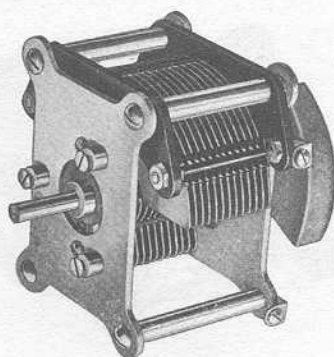

TYPE 334-F

LOW-VOLTAGE MODELS

THESE condensers have stamped metal end plates. The various models are either counterweighted or balanced, as specified in the price list.

Range: See price list.

Rotor Plates: Straight-line wavelength.

Insulation: Hard-rubber plates.

Maximum Voltage: 500 volts, peak.

Drive: Spur-gear-driven vernier as specified in price list.

Finish: Unmounted only.

Dimensions: Panel space, 3¾ x 3¾ inches. Depth, see price list.

Type	Capacitance			Depth	Weight	Code Word	Price
	Max.	Min.					
334-F	500 μf	20 μf Counterweight	4¼ in.	1½ lb.	BEGIN	\$3.25
334-H	500 μf	20 μf Gear.....	4 in.	1⅝ lb.	BELAY	4.00
334-N	350 μf	20 μf Counterweight	4 in.	1⅜ lb.	BESET	3.00
334-P	350 μf	20 μf Gear.....	3¾ in.	1½ lb.	BEVEL	3.75
334-K	250 μf	15 μf Counterweight	3½ in.	1 lb.	BELOW	2.75
334-M	250 μf	15 μf Gear.....	3¼ in.	1⅞ lb.	BERYL	3.50

HIGH-VOLTAGE models are similar to the low-voltage models except that the spacing of the plates is doubled. They are designed for use in amateur high-frequency transmitters.

Maximum Voltage: 3500 volts, peak.
Drive: Vernier gears cannot be supplied.
Finish: Four mounting feet furnished on all units.

Type	Capacitance		Depth	Weight	Code	Price
	Max.	Min.				
334-Z	500 μ ft	35 μ ft	11 in.	4 lb.	BOGAY	\$10.00
334-R	250 μ ft	30 μ ft	6 1/2 in.	2 lb.	RISON	5.50
334-T	100 μ ft	15 μ ft	4 in.	1 1/8 lb.	RTLY	2.75
334-V	50 μ ft	10 μ ft	3 3/4 in.	5/8 lb.	RRED	2.50

TYPE 374 VARIABLE AIR CONDENSERS

THESE condensers are similar in construction to the Type 334 Variable Air Condensers, except that the rotor plates are cut to give a straight-line-frequency variation. The two smaller sizes are not counterweighted.

Range: See price list.
Rotor Plates: Straight-line frequency.
Insulation: Hard-rubber supports.
Maximum Voltage: 500 volts, peak.
Drive: No vernier gears can be supplied.
 The two single-section models are not counterweighted.
Finish: Unmounted only.
Dimensions: Panel space, 3 3/4 x 3 3/4 inches. Depth, see price list.

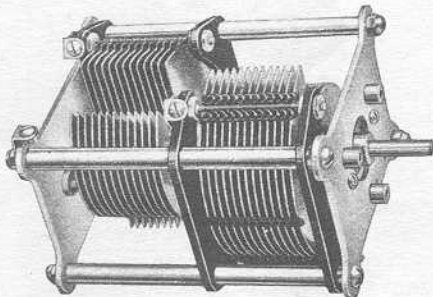

TYPE 374-F

Type	Capacitance		Depth	Weight	Code	Price
	Max.	Min.				
374-Z	125 μ ft	15 μ ft	3 1/4 in.	7/8 lb.	BONS	\$2.75
374-K	250 μ ft	20 μ ft	4 1/4 in.	1 1/4 lb.	BOSM	3.50
374-N	350 μ ft	30 μ ft	5 in.	1 5/8 lb.	BOXER	4.25
374-F	500 μ ft	40 μ ft	6 in.	2 lb.	BRAVO	5.00

TYPE 335-Z VARIABLE AIR CONDENSER

THE TYPE 335-Z Variable Air Condenser is similar to the Type 334 Variable Air Condensers except that it has semi-circular plates. It is intended to be used with Type 380 and Type 219 Decade Condensers to furnish the continuously variable portion below the 0.001 μ f decade.

Range: See price list.
Rotor Plates: Straight-line capacitance (semi-circular).
Insulation: Hard-rubber plates.
Maximum Voltage: 500 volts, peak.

Type	Capacitance		Depth	Weight	Code	Price
	Max.	Min.				
335-Z	1000 μ ft	40 μ ft	5 7/8 in.	2 1/4 lb.	BOGUS	\$6.00

TYPE 556 AMATEUR-BAND CONDENSER

THIS condenser has been designed for use in short-wave receivers and frequency meters where it is desired to spread a narrow band of frequencies over the whole 180° of the condenser scale. The spreading out is accomplished by giving the condenser a large value of zero capacitance. Three of the five rotor plates are complete circles, so that, in effect, the unit consists of a fixed condenser and a variable condenser in parallel. The circular plates also serve to shield the unit from "hand capacitance."

The capacitance values are such that, when the condenser is used in a dynatron-oscillator circuit, it will easily span the 3500 kc. to 4000 kc. amateur band with an approximately straight-line-frequency variation. By moving the outside circular rotor plate, which is held to the shaft by a collar and setscrew, it is possible to adjust the zero capacitance and, therefore, the frequency ratio over a considerable range.

This condenser supersedes the TYPE 557 Amateur-Band Condenser.

Rotor Plates: Three circular (360°) and two plates cut to give an approximately straight-line-frequency variation.

Insulation: Hard-rubber supports.

Maximum Voltage: 3500 volts, peak.

Figure of Merit: 0.03×10^{-12} .

Mounting: Unmounted model only. Sup-

plied with mounting screws and drilling template. No counterweight is required for this condenser.

Dimensions: Panel space, $3\frac{3}{4} \times 3\frac{3}{4}$ inches. "Depth" in the price list gives overall distance that the unit extends behind the panel.

Type	Capacitance		Depth	Weight	Code Word	Price
	Max.	Min.				
556	81 μf	53 μf	2 $\frac{7}{8}$ in.	1 lb.	AWARD	\$3.50

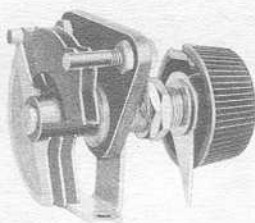

TYPE 368-A

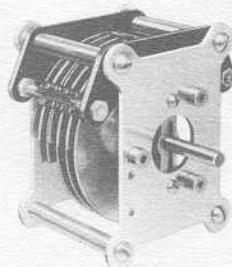

TYPE 556

TYPE 368 VARIABLE AIR CONDENSERS

THESE condensers are useful as balancing or vernier condensers in various vacuum-tube circuits, and many amateurs use them for tuning condensers on their receivers for the high-frequency (short-wave) bands. They have a single hard-rubber end plate, single bearing, and single-hole mounting as well as baseboard mounting.

Rotor Plates: Straight-line capacitance (semi-circular).

Insulation: Single hard-rubber end plate.

Maximum Voltage: 500 volts, peak.

Drive: TYPE 137-J Knob. No vernier.

Finish: Unmounted only.

Dimensions: Panel space, 2 inches diameter. Depth, see price list.

Type	Capacitance		Depth	Weight	Code Word	Price
	Max.	Min.				
368-A	15 μf	4 μf	1 $\frac{7}{8}$ in.	2 oz.	BULLY	\$0.75
368-B	50 μf	4 μf	2 in.	2 $\frac{1}{2}$ oz.	BURIN	1.00
368-C	100 μf	4 μf	2 $\frac{1}{4}$ in.	3 oz.	AZURE	1.75

VOLUME-CONTROL DEVICES

BECAUSE so many factors affect the design and manufacture of volume controls and because the voice-frequency transmission, recording, and projection industries have grown so rapidly, engineers responsible for specifying and installing these devices have had to content themselves with whatever has been available on the market. The General Radio Company has been studying the requirements of the field and has completed the development of units that meet the most rigid and exacting service requirements. Full details are given in this section. The new line includes regular volume controls, mixing controls, and faders for sound projection.

There are three primary factors to be considered when specifying volume controls of any kind:

- The values of terminal impedance which the network must match to minimize reflection losses and the frequency discrimination resulting therefrom.
- The range of attenuation that the volume control must have and the amount of attenuation per step.
- The type of section (whether voltage divider, L-type, T-type, H-type, etc.) which involves the considerations mentioned in (a) as well as the possibility of crosstalk resulting from line unbalances to ground. The construction of each of these different sections is illustrated schematically in the accompanying diagrams.

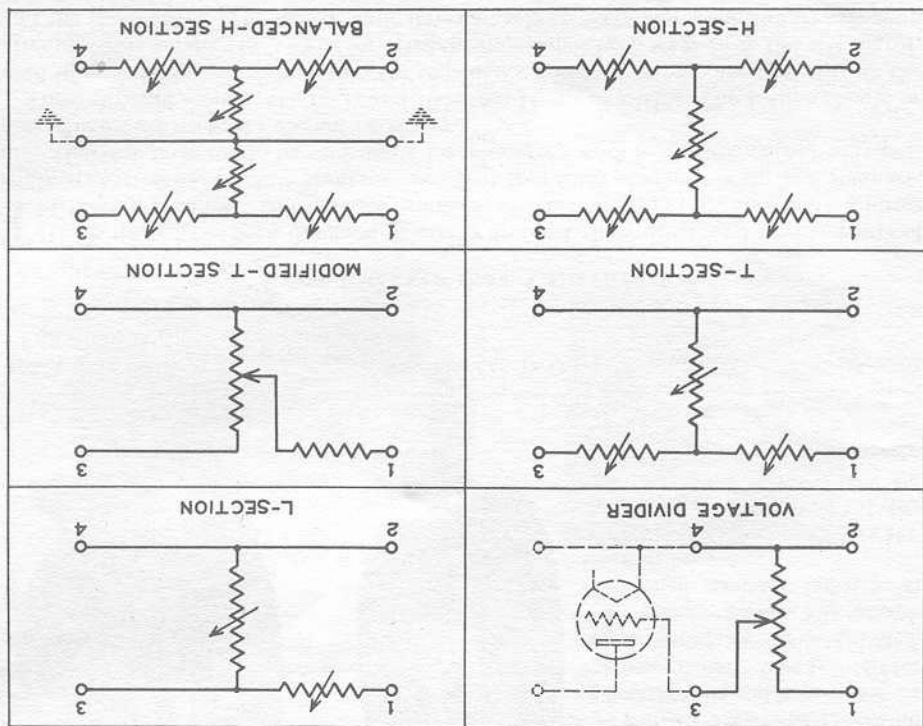

The six most used volume-control sections

Other conditions which a good volume control must meet include: rugged mechanical design, ease of operation, freedom from reactance and stray admittances in the network, reasonable shielding from electrical disturbances and from dust, freedom from contact and switch noise. The latter is most frequently overlooked, probably because volume controls built from modified radio rheostats have been the cheapest and easiest to secure. (The General Radio Company's experience with sliding contacts on wire justifies the belief that they have no place in a high-grade permanent installation. We can, however, supply them.)

TYPE 598-A FADER

THIS fader is as rugged in construction, convenient to operate, and free from contact noise and service troubles as good workmanship and material can make it. The mounting and switching mechanism will withstand an indefinite amount of ordinary use. The instrument can be supplied either with or without a dummy control. If a dummy control is used, there is no appreciable backlash between the dial of the dummy and master units, because the connecting drive is direct and involves no gears. The resistance units and contacts are carefully shielded to protect them from electrical disturbances and dust.

Range: Fifteen steps on each side of zero, with 2 or 3 decibels per step as specified.

Type of Winding: Unifilar winding on bakelite cores.

Accuracy of Adjustment: Resistors adjusted to within 0.5 percent.

Type of Section: Modified T-type.

Terminal Impedances: 200 or 500 ohms terminal impedance are the most usual. Can be built for any terminal impedance specified.

Frequency Error: The above-mentioned accuracy holds to at least 10 kc.

Finish: Crackle-finish cast aluminum with an engraved bakelite terminal plate and specially engraved scale with large numerals.

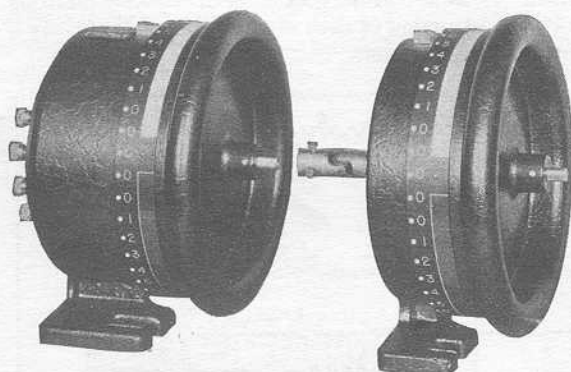

Type	Power Level Range	Section	Impedance	Code Word	Price
598-A	To Order	Modified T†	To Order	On Request

† As shown on page 7.

TYPE 552 VOLUME CONTROLS

THESE units have been designed primarily to meet the voice-circuit requirements of high-grade broadcast transmission, sound recording and projection, and public-address equipment. Because of their accuracy, excellent frequency characteristics, and compactness, they will be found to be very useful for laboratory work in circuits where highly precise attenuation networks are not necessary.

Three types of section, the L, T, and Balanced-H, are available. The L-type should be used when it is desired to maintain the impedance constant in one direction only as the attenuation is varied, the T-type for constant impedance both ways from the attenuator, and the Balanced-H-type for constant impedance both ways and when the transmission circuit is to be balanced to ground.

The units are assembled so that clockwise rotation of the switch reduces the attenuation. The scale is engraved for each step from 20 to 0 with decreasing numbers in the clockwise

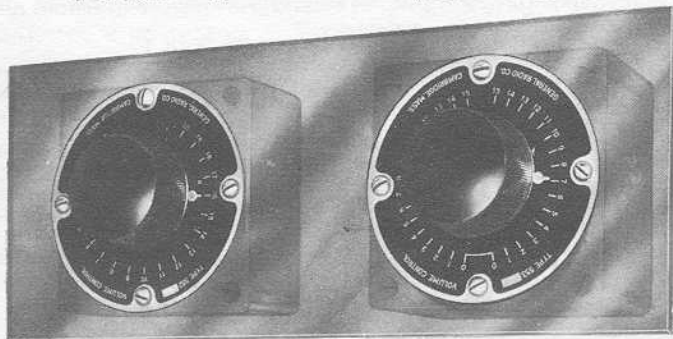

TYPE 553 (left)

TYPE 552 (right)

The loss in decibels actually introduced by the attenuator is found by multiplying the scale reading by the attenuation elements per step (1.5 db per step).

The design of the resistance elements permits of very rigid mechanical construction. The whole assembly is built to withstand the most severe service requirements. An adequate metal shield which covers the terminals is provided for electrical and mechanical

disturbances.

No slide-wire contacts are used. This increases the reliability of the unit, at the same time

making duplication of attenuator settings easily possible. Step-by-step contacts also have

a considerably lower noise level than any type of sliding contact. These contacts have been

run for 200,000 operations without appreciable wear. A thin film of clock oil is recom-

mended for lubrication of the contacts. This will not interfere in any way with the

electrical contact but will decrease wear considerably.

Panel mounting is accomplished by using the circular etched-metal name plate which

carries the scale as a drilling template. The same screws that mount the attenuator in the

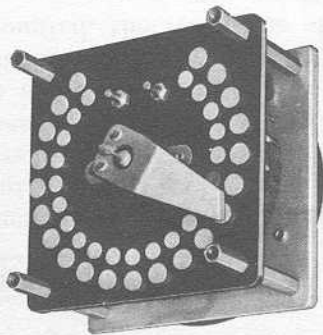

TYPE 552-1A
(without dust cover)

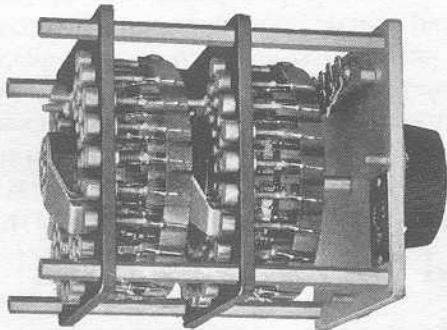

TYPE 552-HB
(without dust cover)

Range: 0 to 30 db in 20 steps of 1.5 db

each.

Type of Winding: Uniform on thin bake-

lite strips.

Accuracy of Adjustment: All resistances

are adjusted to within ± 2 per cent.

Terminal Impedance: See price list.

Weight: Varies with model. See price list.

Dimensions: All models require 4 in. x 4

in. panel space. The depth behind the panel

varies with the model. See price list.

Frequency Error: The attenuation is in

error by not more than ± 1 db at all set-

tings up to 20 kilocycles.

Frequency Error: The attenuation is in

(Continued on following page)

Type	Attenuation	Section	Impedance	Depth	Weight	Code Word	Price
552-LA	30 db in steps of 1.5 db	L	50 ohms	2 $\frac{5}{8}$ in.	1 $\frac{3}{4}$ lbs.	AFIRE	\$28.00
552-LB	30 db in steps of 1.5 db	L	200 "	2 $\frac{5}{8}$ in.	1 $\frac{3}{4}$ lbs.	AFTER	28.00
552-LC	30 db in steps of 1.5 db	L	500 "	2 $\frac{5}{8}$ in.	1 $\frac{3}{4}$ lbs.	AHEAD	28.00
552-TB	30 db in steps of 1.5 db	T	200 "	3 in.	2 lbs.	ALIEN	34.00
552-TC	30 db in steps of 1.5 db	T	500 "	3 in.	2 lbs.	ALARM	34.00
552-HB	30 db in steps of 1.5 db	Balanced-H	200 "	5 $\frac{1}{4}$ in.	3 lbs.	ALBUM	48.00
552-HC	30 db in steps of 1.5 db	Balanced-H	500 "	5 $\frac{1}{4}$ in.	3 lbs.	AGAIN	48.00

NOTE: These items are carried in stock. Units having detent contacts or different values of terminal impedance and attenuation per step can be built to order.

TYPE 553 VOLUME CONTROLS

THESE are similar in general construction to the TYPE 552 Volume Controls. They are designed for transferring the amplifying system, or fading, between two microphones or phonograph pickup units, at the same time making available a volume control for the unit in use. A range of 30 db in level is available in 2-db steps.

The network used is the usual Modified-T-type. With this network the output impedance varies from 30 per cent. low to 20 per cent. high from the specified impedance value when going from minimum to maximum setting of the switch. At the same time the input impedance from the pickup or microphone is varying from 0 error to 27 per cent. low from the specified impedance. These errors, unavoidable in this type of network, are not sufficient to interfere with the performance of the pickup system.

Range: 0 to 30 db in 15 steps of 2 db each on each side of zero.

Frequency Error: A maximum error of ± 0.2 db is maintained at all settings up to

Type of Winding: } Same as TYPE
Accuracy of Adjustment: } 552 Volume
Terminal Impedance: } Controls

20 kilocycles.

Weight: See price list.

Dimensions: Same as TYPE 552.

Type	Attenuation	Section	Impedance	Depth	Weight	Code Word	Price
553-FB	30 db in steps of 2 db	Modified-T	200 ohms	3 $\frac{1}{2}$ in.	2 lbs.	ALDER	\$28.00
553-FC	30 db in steps of 2 db	Modified-T	500 "	3 $\frac{1}{2}$ in.	2 lbs.	ALERT	28.00

RHEOSTATS AND POTENTIOMETERS

THE ruggedness of these units makes them ideal for general-purpose resistance controls, especially for filament rheostats and volume controls in apparatus using vacuum tubes. Wire is wound on non-absorbent strips which are held in place on bakelite bases.

Their flexibility is an important feature in experimental work. All (except TYPE 410, which is for panel mounting only) may be mounted either on table or panel. When panel-mounted, the resistance of all rheostats decreases for clockwise rotation of the control knob; when table-mounted, the resistance of all rheostats but one* decreases for counter-clockwise rotation, but it is an easy matter to reverse the connections if necessary. Potentiometers used as rheostats

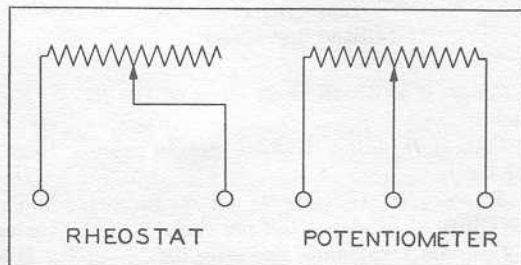

*TYPE 214. 50-ohm Rheostat.

will, of course, operate in either direction without changes, inasmuch as a potentiometer is merely a rheostat with a third terminal. Current-carrying capacities are limited by allowable heat dissipation which is the principal characteristic that distinguishes one type of unit from another. The greater the allowable heat, the larger the winding form required, and, of course, the greater the total resistance that it is possible to secure.

For volume-control use, it is often convenient to make use of a potentiometer whose resistance is not proportional to the angle of rotation. The TYPE 371-T Potentiometer is wound on a tapered strip, the resistance corresponding to any setting being approximately proportional to the square of an angle equal to 80° plus the actual angle of rotation. All resistances are wound to within 10 per cent. of specified values. Sizes listed are carried in stock; others can be built to order.

TYPE 371 POTENTIOMETERS

Maximum Power Dissipation: 25 watts for linear model, 15 watts for tapered model.
Mounting: Supplied for 3-hole panel mounting, but can easily be converted for baseboard mounting. Machine screws, nuts, and drilling template furnished.

Dimensions: Overall radius including terminals, 1 1/2 inches; depth behind panel, 2 3/8 inches; shaft, 1/4 inch. Angle of Rotation: 305°. No "off" position.
Knob: TYPE 137-D.
Weight: 7 ounces.

LINEAR MODELS

Type	Total Resistance	Maximum Current	Code	Price
371	1 ohm	5 amperes	RALLY	\$5.00
371	5 ohms	2.2	RELAY	5.00
371	1000	150 milliamperes	REDAN	5.00
371	2500	100	REFIT	5.00
371	5000	70	ROTOR	5.00
371	10,000	50	HOWDY	5.00
371	18,000	37	RULER	5.00
371	50,000	22	SATYR	6.50

TAPERED MODELS

Type	Total Resistance	Maximum Current	Code	Price
371-T	10,000 ohms	40 milliamperes	SULLY	\$6.00

TYPE 214 RHEOSTATS

Maximum Power Dissipation: 12 watts. Supplied either for 3-hole panel mounting (TYPE 214-A) or for table mounting (TYPE 214-B). One type can be easily converted into the other by the customer. Machine screws, nuts, and drilling template furnished.

Dimensions: Overall radius including terminals, 1 3/4 inches; depth behind panel, 1 1/4 inches; shaft, 1/4 inch. Angle of Rotation: 300°. No "off" position.
Knob: TYPE 137-D.
Weight: 7 ounces.

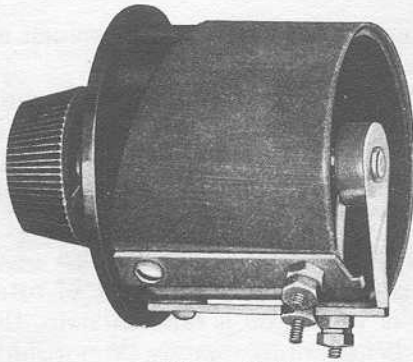

TYPE 371-T

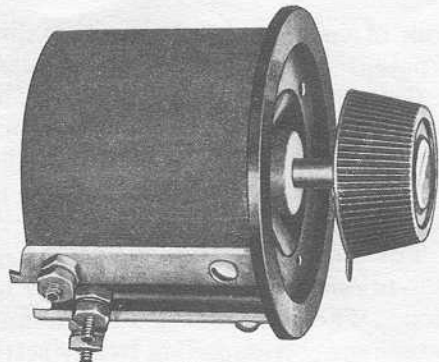

TYPE 371

PANEL-MOUNTING MODELS

Type	Total Resistance	Maximum Current	Code Word	Price
214-A	0.75 ohm	4 amperes	SHINY	\$1.50
214-A	2 ohms	2.5 "	RUDDY	1.50
214-A	7 "	1.3 "	RURAL	1.50
214-A	20 "	0.75 ampere	RAZOR	1.50
214-A	50 "	0.50 "	RAPID	1.50
214-A	2500 "	70 milliamperes	SYRUP	2.00

TABLE MOUNTING MODELS

Type	Total Resistance	Maximum Current	Code Word	Price
214-B	0.75 ohm	4 amperes	SILLY	\$1.50
214-B	2 ohms	2.5 "	RUMOR	1.50
214-B	7 "	1.3 "	RUSTY	1.50
214-B	20 "	0.75 ampere	READY	1.50
214-B	50 "	0.50 "	RAVEL	1.50
214-B	2500 "	70 milliamperes	SYNOD	2.00

TYPE 214 POTENTIOMETERS

TYPE 214 Potentiometers are in every way like the TYPE 214 Rheostats described above except that they are provided with the third terminal. They are likewise available in both panel- and table-mounting models.

PANEL- AND TABLE-MOUNTING MODELS

Type	Total Resistance	Maximum Current	Mounting	Code Word	Price
214-A	400 ohms	175 milliamperes	Panel	ROSIN	\$1.50
214-B	400 "	175 "	Table	ROWEL	1.50

TYPE 301 RHEOSTATS

THESE units are small and occupy little space on the panel or baseboard. Quantities of them are used in General Radio instruments.

Maximum Power Dissipation: 6 watts.

Mounting: Supplied for 2-hole panel mounting, but can easily be converted for baseboard mounting. Machine screws and nuts furnished.

Dimensions: Overall radius including ter-

minals, 1 5/16 inches; depth behind panel, 2 3/8 inches; shaft, 1/4 inch.

Angle of Rotation: 255°. Has "off" position.

Knob: TYPE 137-J.

Weight: 4 ounces.

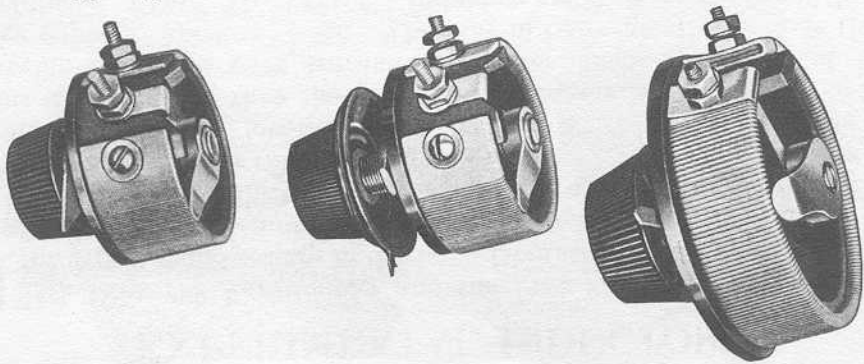

Type	Total Resistance	Code	Word	Price
301	1.5 ohms	PUPIL		\$1.00
301	6	PAISY		1.00
301	12	REMIT		1.00
301	25	RENEW		1.00

TYPE 301 POTENTIOMETERS

THESE are in every respect like the TYPE 301 Rheostats described above except that they are provided with the third terminal.

Type	Total Resistance	Code	Word	Price
301	200 ohms	REBUS		\$1.00

TYPE 410 RHEOSTATS

THESE are exactly like the TYPE 301 Rheostats and Potentiometers except that they are designed for single-hole mounting by means of a threaded bushing.

Maximum Power Dissipation: 6 watts. Shaft, $\frac{1}{4}$ inch. Angle of Rotation: 25°. Has "off" position.

Mounting: Single-hole type. Outside diameter of bushing, $\frac{3}{8}$ inch. Maximum thickness of panel, $\frac{3}{8}$ inch.

Dimensions: Overall radius including terminals, $1\frac{3}{4}$ inches. Depth behind terminals, $1\frac{1}{4}$ inches.

Weight: 4 ounces.

Knob: TYPE 137-L.

Type	Total Resistance	Code	Word	Price
410	0.5 ohm	SAVOR		\$1.00
410	1.5 ohms	SAXON		1.00
410	6	SABOT		1.00
410	12	SALON		1.00
410	25	SALTY		1.00

TYPE 410 POTENTIOMETER

THIS is identical with the TYPE 410 Rheostats except that it has the third terminal and no "off" position.

Type	Total Resistance	Code	Word	Price
410	200 ohms	SATIN		\$1.00

EXPERIMENTAL INDUCTORS

THE TYPE 268 Variocoupler and the TYPE 269 Variometer are ideal for experimental set-ups in the radio laboratory. They are compact, mechanically rugged, and electrically efficient.

The TYPE 577 Inductors are the result of an investigation of losses in coils and coil forms conducted by the General Radio Company several years ago when the "low-loss" coil and condenser craze was at its height. This study showed that the proper ratio of diameter to length and a bakelite coil form gave substantially lower losses than any of the then popular "low-loss" coils. The plug-in bases greatly increase their usefulness. (Note: The TYPE 577 Inductors are the same as the old TYPE 277 Inductors in every respect except arrangement of the holes for mounting pins.)

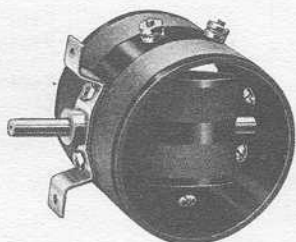

TYPE 268

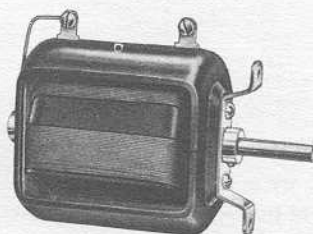

TYPE 269

TYPE 268 VARIOCOUPLER

Inductance Values: See table below.
Shaft Diameter: $\frac{1}{4}$ inch.

Dimensions: 4 x 4 x $2\frac{1}{2}$ inches.
Weight: 6 ounces.

<i>Type</i>	<i>Stator Inductance</i>	<i>Rotor Inductance</i>	<i>Code Word</i>	<i>Price</i>
268	380 microhenrys	106 microhenrys	VALET	\$2.50

TYPE 269 VARIOMETER

Inductance Values: See table below.
Shaft Diameter: $\frac{1}{4}$ inch.

Dimensions: $4\frac{3}{4}$ x 3 x $1\frac{3}{4}$ inches.
Weight: 7 ounces.

<i>Type</i>	<i>Inductance (Series)</i>		<i>Code Word</i>	<i>Price</i>
	<i>Maximum</i>	<i>Minimum</i>		
269	820 microhenrys	100 microhenrys	VALID	\$3.50

TYPE 577 INDUCTORS
SINGLE-WINDING MODELS

THESE are available in three sizes to meet a need for high-grade tuning inductors for the laboratory.

Inductance: See price list.

Tuning Range: See price list. Values given

are maximum and minimum frequencies

for inductors when used with 500- μ ft vari-

able air condenser.

Mounting: Holes provided for TYPE

274-R Plugs (not furnished with inductors).

Drilled to fit TYPE 274-CJ or TYPE 274-EJ

Mounting Bases.

Dimensions: $3\frac{1}{4}$ x $3\frac{1}{4}$ x $2\frac{1}{4}$ inches.

Weight: 3 ounces.



TYPE 577-D

Type	Inductance	Tuning Range	Turns	Code	Word	Price
577-A	16 mch.	6000-2000 kc.	14	NABOB		\$1.00
577-B	60 mch.	3000-1000 kc.	27	NABIB		1.15
577-C	190 mch.	1500-500 kc.	55	NABIV		1.15

THESE are provided with two windings as specified in the price list. They are similar in all other details to the single-winding models.

Inductance: See price list. Values given are for secondary winding.

variable air condenser.

Tuning Range: See price list. Values

Type	Inductance	Tuning Range	Sec. Turns	Pr.	Code	Word	Price
577-D	190 mch.	1500-500 kc.	50	13	NAKED		\$1.15
577-D $\frac{1}{2}$	52 mch.	3000-1000 kc.	26	6	NASAL		1.15
577-D $\frac{3}{4}$	15 mch.	6000-2000 kc.	13	4	NASTY		1.15

UNWOUND MODEL

THIS is provided so that experimenters may wind their own inductors. Specifications are identical with those given for the single-winding models.

Type	Code	Word	Price
577-U	NATAL		\$0.70

TUNING-FORK AND MICROPHONE-BUTTON OSCILLATORS

TYPE 213 AUDIO OSCILLATORS

THE TYPE 213 Audio Oscillators are intended for measurements at fixed frequencies in general, and bridge measurements in particular. They are of the tuning-fork-controlled type, simple and rugged in construction and reliable in operation.

Frequency: Fixed, see price list below.

Power Output: 50 milliwatts maximum.

Harmonics: Harmonic content varies with load impedance. Its magnitude is from 3 to 8 per cent. with normal resistive loads.

Frequency Stability: The maximum change in frequency with load is about 0.1 per cent. This and variations introduced by temperature are entirely negligible for practically all bridge measurements. The actual frequency may be less than the rated value by 0.5 per cent. due to loading the fork with the microphone button.

Output Impedance: Three output ranges are provided permitting the use of loads from 20 to 10,000 ohms.

Power Supply: 6-volt battery, 130 milliamperes.



TYPE 213-C, 400 cps.

Dimensions: Panel, $6\frac{1}{8}$ x $4\frac{3}{4}$ inches.

Depth, see price list.

Weight: See price list.

Type	Frequency	Operated	Depth	Weight	Code Word	Price
*213-B	1000 cps.	6 volts, d.c.	5 in.	5 lb.	ANGEL	\$34.00
*213-C	400 cps.	6 volts, d.c.	$6\frac{1}{8}$ in.	$5\frac{3}{4}$ lb.	AMUSE	42.00

* Oscillators for any 100-cycle multiple between 400 and 1500 cps. may be built to order: 400-600 cps. are TYPE 213-C, 700-1500 cps. are TYPE 213-B. To avoid confusion specify the desired frequency when ordering. Code words and prices apply only to frequencies here listed.

TYPE 241 MICROPHONE HUMMERS

THIS instrument is of the reed type operated by a microphone button. It is intended for use as a low-power alternating-current source for bridge measurements.

Frequency: About 1000 cycles.

Power Output: About 20 milliwatts maximum.

Power Supply: A $4\frac{1}{2}$ -volt battery of the type used as grid-bias batteries in vacuum-tube circuits.

Mounting: Supplied unmounted, #25 holes.

Dimensions: $2\frac{7}{8}$ x $1\frac{3}{8}$ x $\frac{1}{8}$ inches.

Weight: 1 pound.

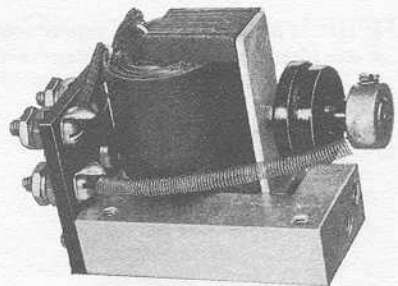

TYPE 241-A

Type	Frequency	Operated	Impedance	Code Word	Price
241-A	1000 cps.	$4\frac{1}{2}$ volts, d.c.	350 ohms	APHIS	\$10.00
241-B	1000 cps.	$4\frac{1}{2}$ volts, d.c.	4.5 "	APIISH	10.00

COUPLING DEVICES

THE group of coupling devices listed below includes instruments to meet nearly all requirements in the audio-frequency range. It includes both input, interstage, and impedance-matching transformers as well as coupling filters for use in coupling vacuum tubes to their output circuits. All of these transformers are sealed in drawn steel cases of the four types shown. Silicon steel cores are used for all types. Silicon steel has been chosen because it is not affected by mechanical shock, is uniform in quality, and heavy current overloads in the windings will not permanently affect it.

The TYPE 585 Amplifier Transformers and TYPE 541 Push-Pull Transformers are made with sectionalized windings. This is done to reduce coil capacitance and to decrease the natural period of the secondary, thus improving their efficiency at higher frequencies.

In the accompanying descriptive data listed, the frequency range of the transformers is that (in cps.) over which the voltage ratio lies within the limit of ± 20 per cent. of its value over the flat portion of the characteristic. It will be noticed that all of the coupling devices listed adequately cover the audio-frequency spectrum. The impedance ranges listed are the impedance limits for the source out of which the transformer will operate within the specified limits of voltage ratio.

TYPE 285 AMPLIFIER TRANSFORMERS

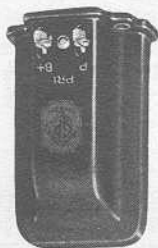

THESE are inexpensive and satisfactory transformers for experimental installations. While they do not cover the wide frequency range possible with larger and higher priced transformers, they have proved quite successful, especially where a saving of space and weight are important considerations.

Mounting: Mounted in the case shown in illustration.

Dimensions: $2\frac{3}{8} \times 2\frac{3}{8} \times 3\frac{1}{2}$ inches (not described in table of dimensions on page 44).

Type	Use	Voltage Ratio	Frequency Range	Impedance	Induct.	Max. D.C. Resistance	Wt.	Code Word	Price
285-D	[1]	1:2.6	75-3200	5000-15,000	40 h.	8 mla.	1200	TOKEN	\$4.00
285-H	[1]	1:3.9	150-5000	5000-15,000	15 h.	10 mla.	2200	TOKEN	4.00
	[1]						1200	TOKEN	

TYPE 585 AMPLIFIER TRANSFORMERS

INTERSTAGE-COUPLING MODELS

THESE are high-quality interstage transformers. They have a high primary inductance and low distributed capacitance in the windings. These factors combine to give the transformer a very flat characteristic over the audio range of frequencies. These transformers are recommended for all high-grade radio and public-address installations. They are mounted in Model B cases.

(Continued on following page)

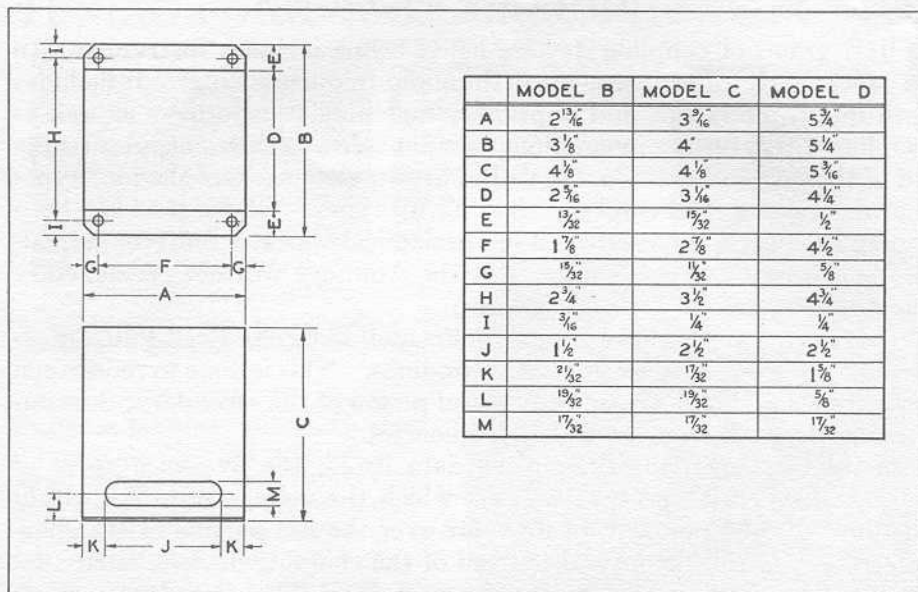

DIMENSIONS OF GENERAL RADIO TRANSFORMER-MOUNTING CASES

LINE-TO-GRID MODELS

SIMILAR in electrical characteristics to the TYPE 585-D and TYPE 585-H, except that the impedance ratio is correct to couple the usual 500-ohm telephone lines to the grid of a vacuum tube, these transformers have a very excellent frequency characteristic. They are mounted in Model B cases.

MICROPHONE-TO-GRID TRANSFORMERS

THESE are high-quality transformers of the proper impedance ratio for coupling low-impedance, 100-ohm microphones to the grid of the first stage amplifier tube. TYPE 585-M Amplifier Transformers are for single microphones, the TYPE 585-M2 Amplifier Transformers have a center-tapped primary winding to permit the use of a double-button microphone. Both transformers have a high-voltage step-up ratio and will carry 100 milliamperes, considerably more current than is usually used in microphone circuits. Both are mounted in Model B cases.

OSCILLOGRAPH-COUPLING MODEL

THIS transformer has a voltage step-down ratio of 18:1 which adapts it for coupling the TYPE 338 String Oscillograph to a vacuum tube. The string circuit has an approximate impedance of 45 ohms. This transformer is designed to work into a load of 30 to 60 ohms. It is mounted in a Model B case.

TUBE-TO-DYNAMIC-SPEAKER MODEL

THIS transformer will operate without impairment of audio quality with a direct current of 55 milliamperes in the primary windings. It is, therefore, adapted for use with any of the power output tubes such as the 245- or 250-types. It has a turns ratio suitable for coupling tubes of this type to low-impedance (5- or 10-ohm) dynamic speakers. It is mounted in a Model B case.

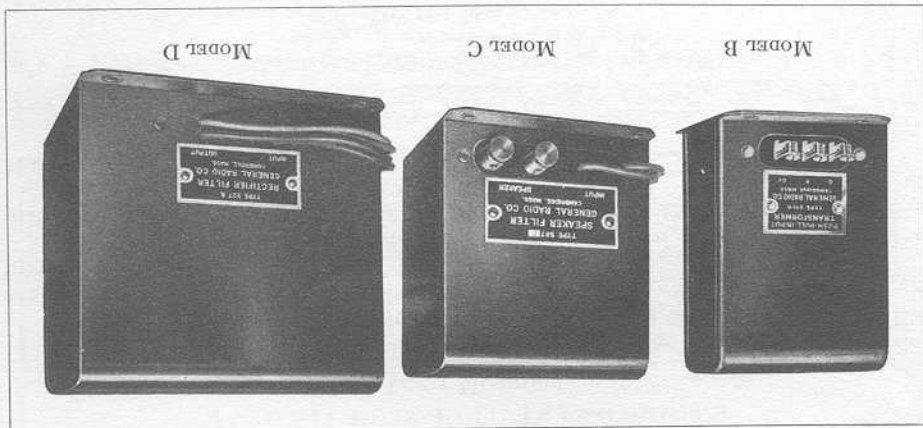

PLATE-TO-LINE MODEL

It is frequently necessary to couple the output of a vacuum tube to a 500- or a 600-ohm telephone line. The TYPE 585-P Plate-to-Line Transformer has been specially designed for this purpose. It is mounted in a Model B case.

Type	Use	Voltage Ratio	Range	Frequency	Source Imped.	Induct.	Max. D.C. Resistance	Wt.	Code	Price
585-D	[1]	1:2	40-8000	5000-15,000	60 h.	12 ma.	2000	2 1/2 lb.	TIMID	\$7.00
585-H	[1]	1:3	40-6000	5000-15,000	50 h.	12 ma.	2000	2 1/2 lb.	TIRST	7.00
585-M	[2]	1:1.5	40-5000	50-150	0.65 h.	100 ma.	20	2 1/2 lb.	TARDY	10.00
585-M2	[3]	1:1.1	80-10,000	150-250	2.4 h.	100 ma.	32	2 1/2 lb.	TARNY	10.00
585-G	[4]	1:1.0	25-5000	400-600	4.8 h.	30 ma.	80	2 lb.	KIOSK	12.00
585-O	[5]	25:1	60-6000	2000-6000	20 h.	55 ma.	464	2 1/2 lb.	TITLB	7.00
585-P	[6]	5:1	60-6000	5000-15,000	66 h.	10 ma.	1250	2 lb.	KOKAN	12.00
585-N	[7]	18:1	60-5000	5000-15,000	40 h.	10 ma.	500	2 1/2 lb.	ORSSH	8.00

[1] Amplifier input and interstage

[2] Amplifier input, single-button microphone-to-grid

[3] Amplifier input, double-button microphone-to-grid

[4] Amplifier input, line-to-grid

[5] Amplifier output, plate-to-low-impedance speaker

[6] Amplifier output, plate-to-line

[7] For use primarily as an impedance-matching transformer with the Type 338 String Oscillograph

TYPE 573-A RESISTANCE-IMPEDANCE COUPLER

WHEN it is desired to build an amplifier having an exceptionally good frequency characteristic, it is often accomplished by using impedance coupling. The TYPE 573 Resistance-Impedance Coupler has been built up to furnish such a compact unit. It consists of a 400-henry inductance coil and a 1-megohm resistance coupled by a 0.2- μ f condenser. The voltage ratio of such an arrangement between input and output is unity, and the frequency characteristic is practically flat from 30 to 10,000 cycles. It is mounted in a Model C case.

Type	Use	Voltage Ratio	Range	Frequency	Source Imped.	Inductance	Max. D.C. Resistance	Wt.	Code	Price
573-A	[1]	1:1	30-10,000	2000-20,000	400 h.	12 ma.	8500	3 lb.	JOLRY	\$10.00

[1] Amplifier input and interstage

TYPE 541 PUSH-PULL TRANSFORMERS

INPUT MODELS

THE push-pull connection is becoming almost universal for the output circuits of audio amplifiers. This connection results in the elimination of a considerable part of the second harmonic distortion that results when approaching the overload point of a single tube.

The windings of these transformers have been split into several sections and arranged so that each half of the double secondary has an equal coupling with the primary. The frequency and performance characteristics are unusually good. They are mounted in Model B cases.

Type	Use	Voltage Ratio	Range		Primary			Wt.	Code Word	Price
			Frequency	Source Imped.	Induct.	Max. D.C.	Resistance			
541-A	...	1:3	40-8000	2500-15,000	42.8 h.	10 mla.	1750 ohms	2½ lb.	TALLY	\$7.50

OUTPUT MODELS

THESE two transformers have been designed for coupling the usual amplifier output tubes such as the 245-, 210-, or 250-types in the push-pull arrangement to their output circuits. The TYPE 541-B model is built with the auto-transformer connection for use with a magnetic (high-impedance) speaker. The direct current is eliminated from the speaker windings by two 4- μ f condensers. It is mounted in a Model C case.

The TYPE 541-C model has two windings with the proper turns ratio for use with the dynamic (low-impedance) speaker. It is mounted in a Model B case.

The primary windings are adequately built to carry the plate current of the larger size tubes. When used in conjunction with the TYPE 541-A Push-Pull Input Transformer, a high-quality push-pull amplifier with an exceptionally flat frequency characteristic results.

Type	Use	Voltage Ratio	Range		Primary*			Wt.	Code Word	Price
			Frequency	Source Imped.	Induct.	Max. D.C.	Resistance			
541-B	...	1:2:1	60-10,000	2500-15,000	15.0 h.	45 mla.	375 ohms	3 lb.	TORSO	\$7.50
541-C	...	35:1	30-10,000	2500-15,000	19.0 h.	45 mla.	375 "	3 lb.	TAPER	7.50

* Data is for one section of the double winding.

TYPE 359 VARIABLE-RATIO TRANSFORMERS

IN a great many circuits it is necessary to couple two elements of different impedances together in such a way that there is no impedance mismatch at the junction. This impedance adjustment is necessary in order to minimize reflection loss at the junction; also necessary in order to terminate calibrated networks properly so that the calibration will be correct.

The TYPE 359 Variable Ratio Transformers are provided with secondaries tapped at seven places. The turns ratio is conveniently varied by means of the switch on which is engraved the secondary-to-primary turns ratio. These transformers are available in several models for different types of winding, impedance, and turns ratio as listed below. All are provided with jack-top binding posts to fit the TYPE 274 Plugs, which feature facilitates circuit changes. They are mounted in Model C cases and weigh 3½ pounds.

TWO-WINDING MODELS

Type	Voltage Ratio	Range		Primary			Code Word	Price
		Frequency	Source Imped.	Inductance	Max. D.C.	Resistance		
359-A	[1]	40-4000	5000-20,000	10.3 h.	15 mla.	700 ohms	PILOT	\$20.00
359-B	[2]	30-5000	5000-20,000	10.3 h.	15 mla.	700 "	PIOUS	20.00
359-E	[1]	40-4000	500- 600	0.7 h.	40 mla.	41 "	POKER	20.00
359-F	[2]	30-4000	500- 600	0.7 h.	40 mla.	28 "	POLAR	20.00

COUPLING DEVICES

AUTO-TRANSFORMER MODELS

Type	Voltage Ratio	Range	Frequency	Source Imped.	Inductance	Max. D.C. Resistance	Code Word	Price
359-C	[1]	30-5000	5000-20,000	12.0 h.	15 ma.	470 ohms	PIVOT	\$20.00
359-D	[2]	40-4000	5000-20,000	12.0 h.	15 ma.	500	PLAZA	20.00
359-G	[1]	30-10,000	500-600	0.7 h.	40 ma.	20	POLKA	20.00
359-H	[2]	30-10,000	500-600	0.7 h.	40 ma.	20	POPPY	20.00

[1] Voltage ratio, secondary to primary: 0.25, 0.35, 0.5, 0.7, 1.0, 1.4
 [2] Voltage ratio, secondary to primary: 0.06, 0.09, 0.13, 0.18, 0.23, 0.35

TYPE 166 TELEPHONE TRANSFORMERS

SIMILAR in use to the TYPE 359 Variable-Ratio Transformers, the TYPE 166 Telephone Transformer is particularly useful for bridge balancing when telephones are used for null detection. With this transformer it is possible to adjust the impedance of the detector circuit independent of the telephone-receiver impedance.

Taps are brought out to binding posts for both the primary and secondary windings so that the number of turns on either can be changed. The turns are engraved on the bakelite panel carrying the binding posts. Primary: 150, 300, 600. Secondary: 1200, 2400, 4800.

Mounting: Core supported in brackets without a case. *Weight:* 2 pounds.

Type	Frequency Range	Code Word	Price
166	150-5000 cps.	TOPIC	\$7.00

TYPE 387-A SPEAKER FILTER

THIS speaker filter is well suited for coupling the 112- or 171-type tube to its output circuit so that the plate current of the tube is eliminated from the windings of the speaker. This is an inexpensive instrument admirably suited for this type of work.

Weight: 2½ pounds.

TYPE 587-B SPEAKER FILTER

THIS speaker filter consists of a high-inductance winding constructed to carry the plate current of the 245-, 210-, or 250-type tubes. The direct current is kept from the speaker windings by two condensers of 4 µf each, which isolate both ends of the inductance from the speaker circuit, eliminating the danger of short circuit of the plate voltage in case either of the speaker windings becomes grounded.

Weight: 4 pounds.

TYPE 587-C SPEAKER FILTER

THIS instrument is built to carry an even higher plate current than the TYPE 587-B model, the relative current-carrying capacities being given in the table below. The coil inductance is consequently slightly less. The direct current is eliminated from the speaker windings in this filter by means of a single 4-µf condenser located at the high side of the windings. Care must be taken in using this speaker filter, since a ground in the re-producer circuit will short-circuit the plate-supply voltage. However, due to the fact that a series capacitance of 4 µf is in the speaker circuit, the TYPE 587-C Speaker Filter has a lower frequency range than the TYPE 587-B model.

Weight: 4¼ pounds.

Type	Frequency Range	Source Imped.	C	Inductance	Max. D.C. Resistance	Case	Code Word	Price
387-A	30-10,000	1500-7500	2 µf	30 h.	30 ma.	550	H	\$4.50
387-B	50-10,000	1500-5000	2 µf	30 h.	75 ma.	550	C	9.00
387-C	40-10,000	1500-5000	4 µf	100 h.	100 ma.	700	C	8.00

POWER TRANSFORMERS

POWER transformers suitable for use with power-supply systems for all types of tubes used in radio receiver- and low-power-transmitter design are listed below.

TYPE 565 TRANSFORMERS

THESE are designed to supply plate and filament power for the 210- and 250-types of tube. They are supplied with an auxiliary filament winding for operating the 281-type rectifier tube, and are designed for operation from 105- to 115-volt, 50- to 60-cycle lines. They have a power rating of 200 watts. They are mounted in Model D cases. Filament windings have no center tap.

HALF-WAVE MODEL

Type	Secondary I		Secondaries II & III		Secondary IV		Power	Weight	Code Word	Price
	Volts	Amp.	Volts	Amp.	Volts	Amp.				
565-A	600	0.2	7.5	2.5	2.25	4	200 watts	14¼ lb.	TABOO	\$13.50

FULL-WAVE MODEL

Type	Secondary I		Secondaries II & III		Power	Weight	Code Word	Price	
	Volts	Amp.	Volts	Amp.					
565-B	600-0-600	0.2*	7.5	2.5	200 watts	14¼ lb.	TACIT	\$13.50

* For two windings in parallel as used with full-wave rectifier.

TYPE 545 TRANSFORMERS

THESE are designed to supply the plate and filament power for the 245-type tube. They are provided with an auxiliary winding for the filament of the 280-type rectifier tube. They have a power rating of 70 watts and are designed to operate from a 105- to 115-volt line at 50 to 60 cycles. When heavy current drain or high resistance in the filter circuit make a higher transformer voltage advisable, the TYPE 545-B Transformer is recommended. They are mounted in Model D cases. Filament windings have no center tap.

Type	Secondary I		Secondary II		Secondary III		Power	Weight	Code Word	Price
	Volts	Amp.	Volts	Amp.	Volts	Amp.				
545-A	300-0-300	0.08*	2.5	3.25	5.0	2.0	70 watts	4¾ lb.	POSSE	\$10.00
545-B	350-0-350	0.08*	2.5	3.25	5.0	2.0	70 "	5 lb.	PRIOR	10.00

* For two windings in parallel as used with full-wave rectifier.

TYPE 540 FILAMENT TRANSFORMER

THE heater-filament voltage for the popular alternating-current 227-type and 245-type tubes is standardized at 2.5 volts. This transformer is designed to supply sufficient filament power for any number up to about ten of these tubes in parallel. Two filament windings are provided.

It has a power rating of 70 watts and is designed for operation on 105- to 115-volt, 50- to 60-cycle lines. It is mounted in a Model C case.

Type	Secondaries I & II		Power	Weight	Code Word	Price
	Volts	Amp.				
540	2.5†	8	70 watts	5 lb.	TRIAD	\$10.00

† With center tap.

RECTIFIER FILTERS

THE equipment described in this section is intended for smoothing the output of a power transformer and rectifier so that it may be used for the plate supply of vacuum tubes. The inductors are conservative in rating and have the specified inductance at rated current.

TYPE 527-A RECTIFIER FILTER

THIS is a two-section π -type filter, suitable for use as a smoothing filter in a high-voltage, high-power rectifier.
 Inductance per Section: 15 henrys.
 Direct-current Resistance per Section: 175
 Voltage Rating of Condensers: 1000 volts.
 Current Rating of Inductors: 100 milliamperes.
 Dimensions: Model D case. See table.
 Weight: $9\frac{1}{2}$ pounds.

Type	Inductance	Max. Current	Resistance	Capacitance	Maximum Voltage	Code Word	Price
527-A	15 h.	100 ma.	175 ohms	4-2-4 μ f	1000 volts	FATY	\$17.50

TYPE 366 FILTER CHOKE

THIS consists of two inductors suitable for connection in a two-section filter of the type commonly used for smoothing filters. No condensers are included.
 Inductance per Section: 20 henrys.
 Direct-current Resistance per Section: 350
 Current Rating of Inductors: 50 milliamperes.
 Dimensions: Model D case. See table.
 Weight: $4\frac{3}{4}$ pounds.

Type	Inductance	Max. Current	Code Word	Price
366	20 h. per choke	50 ma.	TRPD	\$5.00

ACCESSORIES

IN this section are described radio-frequency chokes, voltage dividers for the adjustment of output voltages on power-supply units, and center-tap resistors for use with alternating-current tubes. Sockets and theostats are described elsewhere.

TYPE 446 VOLTAGE DIVIDER

THE output of a plate-power supply for experimental work must be adjustable to meet a wide variety of tube conditions. The TYPE 446 Voltage Divider provides three adjustable voltages in the plate-supply sections, and one adjustable grid-bias voltage. Extra sliders may be purchased.
 Resistance: Plate Section, 15,000 ohms; Grid Section, 1500 ohms.
 Dimensions: $7\frac{1}{2} \times 4\frac{5}{16} \times 1\frac{1}{4}$ inches.
 Weight: 5 ounces.

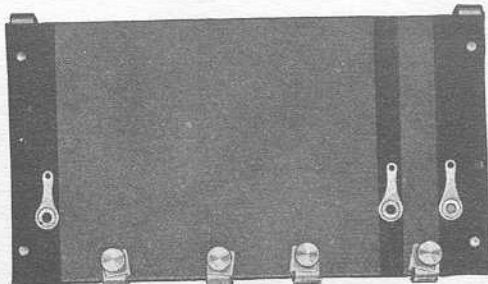

Type	Total Resistance	Maximum Current	Code Word	Price
446-P1	1500-0-1500 ohms	20 milliamperes	VISTA	\$2.75
446-P1	Extra Slider			0.10

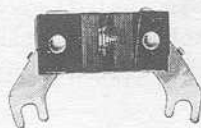

TYPE 439

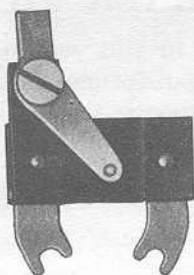

TYPE 437

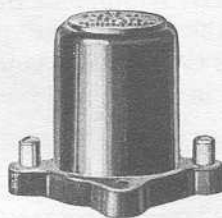

TYPE 379

TYPE 437 AND TYPE 439 CENTER-TAP RESISTANCE UNITS

THE TYPE 437 and TYPE 439 Center-Tap Resistance Units, designed for mounting directly on the filament terminals of the tube socket, offer a convenient means of connection to the mid-potential point of the filament. The position of the tap on the TYPE 437 Center-Tap Resistance Unit is adjustable, permitting the balancing unit of hum by this means.

Characteristics: See price list.

Weight: 1 ounce.

Type	Total Resistance	Maximum Current	Center Tap	Code Word	Price
437	60 ohms	200 milliamperes	Adjustable	PERIL	\$0.50
439	60 "	200 "	Fixed	PASTY	0.35

TYPE 379 RADIO-FREQUENCY CHOKES

THE TYPE 379 Radio-Frequency Chokes are available in two models, one of low inductance to carry a heavy current, and one of high inductance to carry a lower current. The specifications below give the details of the two models. The windings are sectionalized and the effective capacity does not exceed $4\mu\text{f}$. Either model is suitable for use in circuits having a frequency up to 15,000 kc.

Dimensions: $2 \times 1\frac{3}{4} \times 1\frac{3}{4}$ inches.

Weight: 6 ounces.

Type	Frequency Range	D.C. Resistance	Allowable Current		Inductance	Code Word	Price
			Intermit.	Continuous			
379-T	1875-15,000 kc.	35 ohms	300 mla.	140 mla.	8 mlh.	JIMMY	\$1.25
379-R	470-15,000 kc.	140 "	90 mla.	65 mla.	60 mlh.	JEWEL	1.25

AMATEUR FREQUENCY STANDARDS

THE instruments described on this and the following page have been designed to assist the amateur in maintaining the frequency of his transmitter within the bands assigned to him. They have all been thoroughly tested in actual operation to make sure that they conform to the amateur's needs. Calibrations are well within the specified limits of accuracy, and with reasonable care in handling the instrument they should be good for six months or more.

Piezo-electric units manufactured under license from Dr. G. W. Pierce.

TYPE 558-P AMATEUR-BAND FREQUENCY METER

THE TYPE 558-P Amateur-Band Frequency Meter was developed primarily for use by amateurs, and for this reason it covers only narrow ranges of frequency centered in the vicinity of the amateur-frequency bands. The accuracy is 0.25 per cent.

Calibration: Individual calibration in frequency accurate to within 0.25 per cent. supplied.

Condenser: Type 557 Amateur-Band with variable condenser.

Inductors: The instrument is furnished with five inductors. The forms are $1\frac{1}{4}$ -inch diameter, fitted with mounting pins to fit condenser terminals.

Resonance Indicator: None. Designed for use with reaction methods, particularly as indicated by heterodyne methods.

Carrying Case: Space provided for inductors, condensers, and calibration chart.

Dimensions: Carrying case, $11\frac{3}{4}$ x $7\frac{1}{2}$ x $5\frac{1}{2}$ inches.

Weight: $4\frac{1}{2}$ pounds.

Type	Frequency	Accuracy	Code Word	Price
*558-P6	56,000-60,000 kc.	0.25%	UNION	\$18.00
	28,000-30,000 kc.			
	14,000-14,400 kc.			
	7000-7300 kc.			
	3500-4000 kc.			
558-P	5.36-5.00 meters	0.25%	WOVEN	6.00
	10.71-10.00 "			
	21.43-20.83 "			
	42.86-41.1 "			
	85.7-75.0 "			
	175.0-150.0 "			

*Frequency meter with which this inductor is to be used must be submitted with order so that calibration can be made. This inductor is built to order and is not carried in stock.

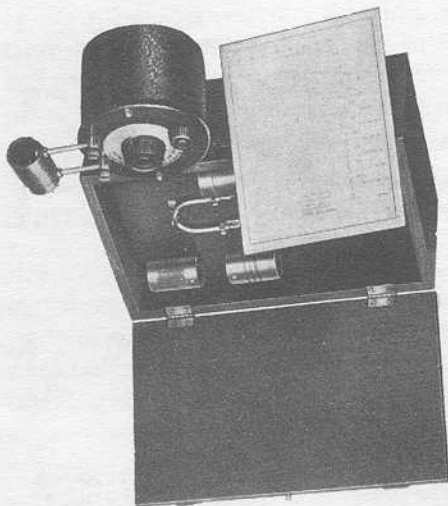

TYPE 358 WAVEMETER

THE TYPE 358 Wavemeter is intended for use as an inexpensive general-purpose device covering a rather wide frequency range with an accuracy of 1 per cent. The instrument is compact and is easily held in the hand while making measurements. In certain cases, the usefulness of the wavemeter may be increased through the addition of two inductors to extend the wavelength range. These inductors are available on special order.

Calibration: In wavelength; accuracy, 1 per cent.

Condenser: TYPE 247 Condenser in shielded case.

Inductors: Four on TYPE 277 forms, fitted with mounting pins to fit condenser terminals.

Resonance Indicator: Small flashlight bulb in special socket which closes circuit on removal of bulb.

Carrying Case: Space provided in wooden box for inductors, condenser and calibration chart.

Dimensions: Carrying case, 11 3/4 x 7 1/4 x 5 1/2 inches.

Weight: 4 1/2 pounds.

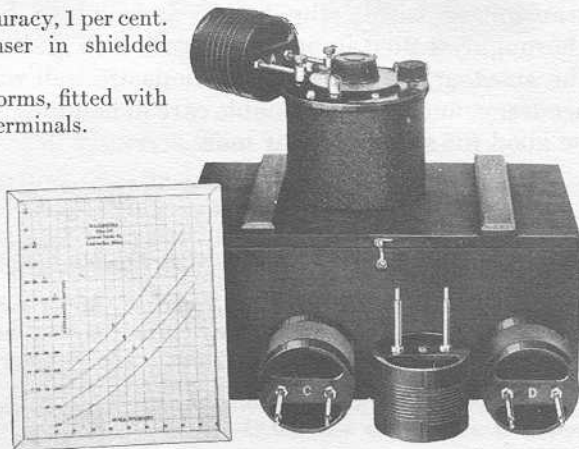

Type	Wavelength	Accuracy	Code Word	Price
358	[20,000-1364 kc.] 15-220 meters	1%	UPPER	\$15.00

TYPE 276-A QUARTZ PLATE

THE TYPE 276-A Quartz Plate is adjusted to have a frequency somewhere in the 160-meter amateur band. The crystals are not mounted. Their calibration may be relied upon to within 0.25 per cent.

Weight: 2 ounces.

Type	Adjusted Within	Accuracy	Code Word	Price
276-A	2000-1715 kc.	0.25%	LABOR	\$15.00

TYPE 356 QUARTZ-PLATE HOLDER

THE TYPE 356 Quartz-Plate Holder is intended for amateur and experimental use, primarily with the TYPE 276-A Quartz Plates. The top electrode rests upon the crystal, but is held in place by a pin passing through a hole in a light spring.

Dimensions: 2 1/2 x 2 1/2 inches.

Weight: 2 ounces.

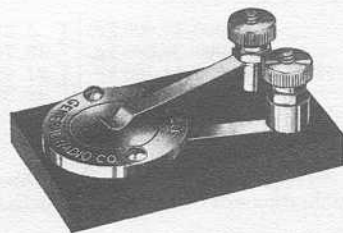

Type	Code Word	Price
356	LASSO	\$1.50

SERVICE-TESTING INSTRUMENTS

THE modern radio receiver with gang-tuning controls and enclosed chassis construction presents a difficult service problem. The cost of servicing such complicated equipment justifies the installation of proper test equipment wherever any considerable volume of service work is being done.

The troubles that may arise in a modern radio receiver may be roughly classified into the following three groups: (a) those due to defective tubes, (b) those due to defects in the audio-amplifier system, and (c) those that appear in the radio-frequency amplifier and detector units. Tube troubles will be disclosed by any one of a number of tube-testing units now on the market; many audio-amplifier troubles may be quite satisfactorily investigated by simple direct-current continuity tests. For making checks upon the radio-frequency system, however, the fundamental testing device that must be used is a modulated radio-frequency oscillator, furnishing a test signal at one or more points in the broadcast band. When neutralizing, when adjusting trimming condensers, when aligning gang-tuning controls, when making general radio-frequency continuity tests, and when making any one of a number of other investigations in the absence of a reliable signal from several different broadcast-ing stations, a test oscillator is an absolute necessity if an intelligent test is to be made. Such a simple radio-frequency driver is described on page 30.

It should also be recognized that an approximate measurement of the sensitivity of a receiver undergoing test is a great help in locating faults since any serious fault is accompanied by a departure from normal sensitivity. A suitable instrument for measuring sensitivity is the TYPE 404 Test-Signal Generator described on page 29. It is the first time that such an instrument has been available to the service man although similar but more elaborate designs have been built by General Radio for the set manufacturer's laboratory.

We recommend that the TYPE 486 Output Meter be used in conjunction with the TYPE 404 Test-Signal Generator. The former instrument is described on page 39 of this bulletin.

Two other important instruments for the service man are the TYPE 240 Capacity Meter and the TYPE 443 Mutual-Conductance Meter. They are not usually encountered in the service laboratory which is trying to operate with a minimum amount of equipment, but the organization that prides itself on a completely outfitted laboratory will do well to investigate carefully the merits of these two devices.

TYPE 360-A TEST OSCILLATOR

TO meet the demand for a general-purpose driving oscillator, the General Radio Company has developed its TYPE 360-A Test Oscillator. This instrument consists of a modulated radio-frequency oscillator which will operate at any point in the broadcast band (500 to 1500 kc.) and in addition, deliver a signal at 175 and 180 kc. for making tests upon the intermediate-frequency stages of superheterodyne receivers. A meter for measuring the power output of the receiver as a means of indicating the optimum adjustment is included.



Frequency: 500 to 1500 kc. continuous, as well as 175 kc. and 180 kc. adjustable, over a 5-kc. band on either side of specified channel frequencies for "peaking" intermediate-frequency transformers in superheterodynes.

The "VERNIER" adjustment for the 175-kc. channel is calibrated at 1-kc. intervals between 170 and 180 kc. This calibration constitutes the only difference between the instrument and the TYPE 360 Test Oscillator which it replaces.

Calibration: Broadcast-band control calibrated directly in frequency with accuracy

of ± 2 per cent.; 175 kc. and 180 kc. channels adjusted to ± 0.25 per cent.

Modulation: By means of grid leak and condenser combination at frequency of approximately 800 cycles, 100 per cent.

Output Meter: Consists of TYPE 488-A Alternating-Current Voltmeter connected at will across 4000-ohm resistance network for simulating high-impedance (cone-type) speaker or directly across a low-impedance voice coil. Pin jacks, connecting cable, and provision for telephone receivers provided.

Tubes and Batteries: One 112-type tube (not included in price of instrument) is required. Replacement through hand-hole in bottom of cabinet. Battery cable for connecting 6-volt filament and 45-volt plate supplies provided. External batteries required. Connecting leads supplied.

Test Tool (shown in lid of box): Consists of bakelite rod with heavy closed loop at one end and flat spade at other. Used for aligning gang-controlled tuning condensers. Closed loop acts as short-circuited turn to reduce inductance of the coil; spade increases effective capacitance of the condenser.

Pilot Lamp: Provided to show when oscillator tube is in operation.

Finish: Engraved bakelite panel mounted in hand-rubbed walnut cabinet with cover and carrying handle. No shielding. All metal parts nickel-plated.

Dimensions: $10\frac{3}{4}$ x $10\frac{3}{4}$ x 7 inches.

Weight: $11\frac{1}{2}$ pounds.

Type	Frequency Range	Code Word	Price
360-A	175, 180, and 500-1500 kc.	OVATE	\$115.00

REMODELING OBSOLETE MODELS: TYPE 320 OR TYPE 360

We are prepared to remodel TYPE 320 and TYPE 360 Test Oscillators so that they can be used for testing present-day superheterodyne receivers. Full information will be supplied on request by the Service Department, General Radio Company. Be sure to give the following information about the test oscillator you propose to remodel: (a) type number, (b) serial number, (c) what if any remodeling has already been done?

TYPE 404 TEST-SIGNAL GENERATOR

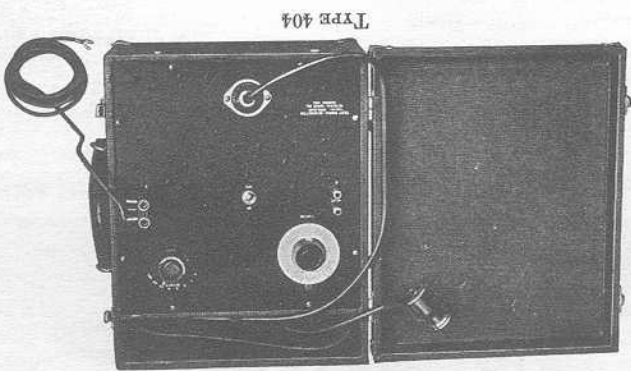

WITH the increasing complication of commercial receivers a signal generator of simplified type is becoming a requirement in radio service work. A generator of this type need not set an exact standard of radio-frequency output, but should present a means of reliable comparisons between receivers, and of the same receiver under different conditions. Such a generator may be used for neutralizing and alignment of receivers, as a check of the receiver's initial condition, and to provide a means of knowing quantitatively the improvement made by means of any changes or adjustments in the receiver.

The comparative sensitivity of a receiver may be measured by means of an adjustable source of radio-frequency voltage. The method is to connect the test generator to the input of the receiver and to connect some sort of output indicator, e.g., the General Radio Type 486 Output Meter, to the output of the receiver. The test generator is then adjusted to give a standard reading on the output meter, and the output of the test generator taken as a measure of the comparative sensitivity of the receiver. The presence of defects will be indicated by the low sensitivity, and conversely, normal sensitivity is definite evidence that the set is not defective, or that defects have been successfully repaired.

The General Radio Type 404 Test-Signal Generator has been designed with the requirement of service testing in mind. It is portable, provides accurate comparisons, and operates from the alternating-current line. The generator consists of a modulated oscillator, tuning over the broadcast band, with a calibrated dial, and an attenuator. The circuits are carefully shielded, and filters prevent leakage into the alternating-current lines.

The attenuator has been carefully designed, and well shielded. The value of the instrument in making comparisons depends entirely on the accuracy of the attenuator, and this portion of the circuit has, therefore, received particular attention. The attenuator has voltage ratios of 1, 2, 5, 10, 20, 50, and 100; a range that will include all modern types of receivers. An additional set of terminals provides an output of about 0.1 volt. The error in attenuator ratios is less than 5 per cent. for adjacent ratios, and the cumulative error in the entire attenuator does not exceed 20 per cent. This means that the instrument will compare the sensitivity of two receivers with an accuracy of 5 to 20 per cent.

The absolute value of the output voltage may vary, due to changes in tubes, or in line voltage. The change in output due to line-voltage variations is approximately proportional to the change in line voltage, and may be corrected for, if the line voltage is measured.

The input to the attenuator is adjustable and is set at the factory. Where facilities are available for setting the input voltage to the attenuator from time to time, correction can be made for changes in tube conditions. The total voltage attenuation from the point of adjustment to the lowest output point is 1:100,000.

The oscillator is so designed that the output voltage is nearly constant over the entire frequency range. The voltage variation is less than plus or minus 5 per cent.

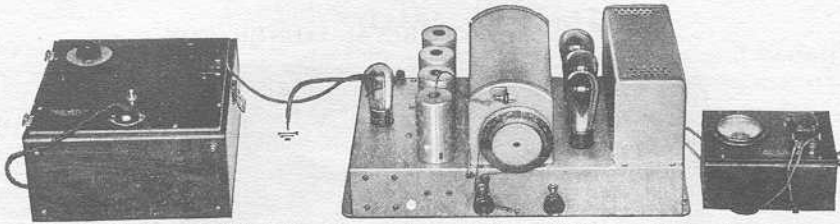

An early model of a TYPE 404 Test-Signal Generator and a TYPE 486 Output Meter set up for measuring the sensitivity of a receiver

Complete isolation from the line is essential in a device of this sort, since it will usually be connected to the same circuit as the receiver under test, and any radiation into the line will be picked up by the receiver. Careful filtering of the power line has eliminated leakage through these leads.

Uses: The TYPE 404 Test-Signal Generator will be found useful in the usual aligning and neutralizing adjustments. A further wide range of usefulness is in assaying the condition of a receiver in question. Since it is portable, it may be taken to the job, and will indicate at once whether or not there is any radical difficulty with the receiver, or whether the trouble is in location, antenna or ground installation, or is only imaginary.

It can further be used to check on the improvement resulting from changing tubes, or making adjustments in the receiver. The test-signal generator may also be used as a test on receivers in factory production.

Modulation: Modulation is obtained from the rectifier tube, i.e., the output from the rectifier tube is not completely filtered. This provides a complex modulation, containing both even and odd harmonics of 60 cycles.

Accuracy: Adjacent ratios 5 per cent.

Cumulative error in attenuator 20 per cent. Change in output with frequency ± 5 per cent. Calibration of tuning dial 3 per cent.

Output Range: Roughly 10-1000 microvolts. 0.1-volt output also provided.

Shielding: The filtering and shielding are such that the instrument may be used with receivers of the highest sensitivity. When the test-signal generator is properly grounded the leakage does not exceed an amount equivalent to 2 microvolts applied directly to the receiver input terminals.

Tubes: Two 226-type tubes are required for operation of the generator.

Construction: The instrument is contained in a shielded compartment of a leatherette carrying case fitted with a carrying handle. Another compartment is provided for storing tools and accessories. The panel is of aluminum with black crackle lacquer. A six-foot extension cord for the power supply and a shielded cable for connecting to the receiver under test are provided.

Type	Tuning Range	Dimensions	Weight	Code Word	Price
404	500-1500 kc. 	14 $\frac{1}{4}$ x 11 $\frac{3}{4}$ x 7 $\frac{1}{2}$ in.	16 lb.	SULKY	\$95.00

TYPE 240 CAPACITY METER

THIS bridge is a variable ratio-arm, unshielded bridge, designed for the measurement of large capacitances at a single frequency of about 1000 cycles per second. Its range is from 0.001 to 11.1 μf with an accuracy of 0.3 per cent. of the maximum reading of its three dials, or, to three units on its smallest dial: minimum reading, 10 μf .

This bridge is portable and completely self-contained. The power source, a microphone hummer, is connected directly to the bridge between the junction of the ratio arms and the junction of the condensers. The standard capacitance is a fixed mica condenser. The added resistance providing the resistance balance is a TYPE 214 Rheostat, calibrated directly in power factor up to 4 per cent. The accuracy of the power-factor setting depends on the actual frequency of the microphone hummer, which may differ from 1000 cycles by 10 per cent., and upon the setting of the ratio arms. This latter dependence is due mainly to the dissymmetry of the ratio arms. It may cause an error in the power-factor reading of 0.5 per cent. (power factor expressed in per cent., not fractional error expressed in per cent.). The reading of the power-factor dial must be considered merely as an indicator of high or low losses.

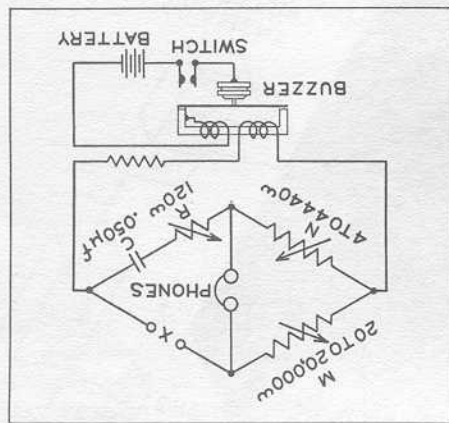
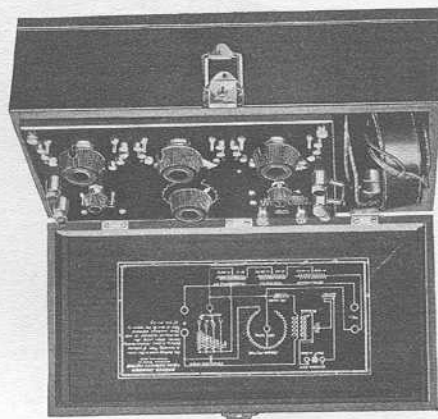

Range: Capacitance, 1000 μf to 11.1 μf .
Power factor, 0 to 4 per cent.
Accuracy: Capacitance, 0.3 per cent. of maximum reading. Power factor, 0.5 per cent. (error in power-factor reading expressed in per cent.).
Ratio Arms: Uniform winding, accuracy of adjustment, 0.1 per cent. M (four resistances) 20-200-2,000-20,000 ohms. N (three-decade resistance) 4-4440 by 4-ohm steps.
Standard Condenser: Mica condenser, 0.05 μf , accuracy of adjustment, 0.25 per cent.
Added Resistance: TYPE 214 Rheostat, 120 ohms.
Dimensions: Top, 7 x 14 1/2 inches; depth, 6 inches.
Weight: 10 7/8 pounds.

Type	Range	Max. Min.	Code Word	Price
240	11.1 μf	1000 μf	CYNIC	\$85.00

TYPE 443 MUTUAL-CONDUCTANCE METER

OF the three important dynamic factors of the three-element vacuum tube, amplification factor, plate resistance, and mutual conductance, the last is the best figure of merit for a tube. While mutual conductance is not a complete indication of the comparative merit of tubes of different types, it offers positive indication among tubes of the same

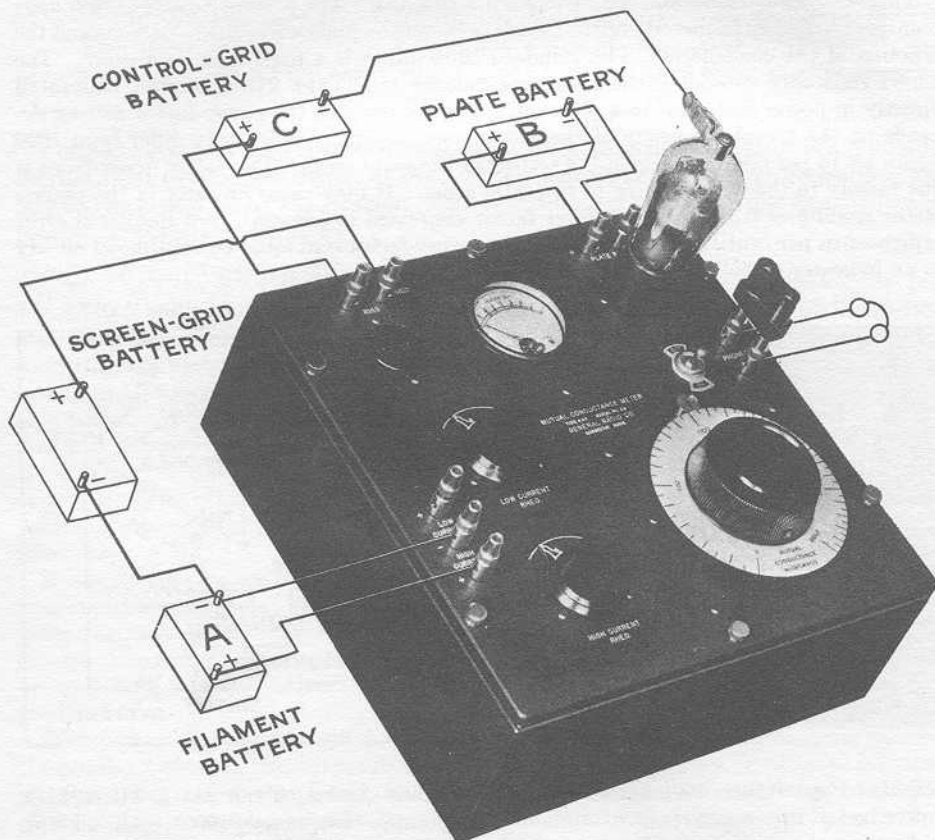

type. This meter will measure the mutual conductance of any receiving tube with a direct-current or alternating-current filament up to 2500 micromhos. It is a bridge which tests the tube under normal conditions. At no time is the tube overloaded.

Range: 0 to 2500 micromhos.

Meter: Filament voltmeter, Weston Model 506, 8-volt.

Resistances: Variable resistance, TYPE 214 Rheostat, tapered, 250 ohms. Fixed resistance, 100-ohm and 1000-ohm cards.

Power Source: TYPE 241-B Microphone Hummer, 1000 cps.

Filament Rheostats: TYPE 214 Rheostat, 4.5 ohms; TYPE 214 Rheostat, 50 ohms.

Sockets: TYPE 349 Socket for UX-base, TYPE 438 Socket for UY-base.

Accessories: Filament, plate, and grid batteries, 4.5-volt dry battery for hummer, plate and grid voltmeters, telephones.

Finish: Units mounted on bakelite panel and enclosed in hand-rubbed walnut cabinet.

Dimensions: Panel, 10 x 10 inches; depth, 4½ inches.

Weight: 6½ pounds.

Type

Code Word Price

443

MUCUS

\$55.00

METERS

To meet the varied needs of the communications industry, a specialized type of meter is required. Certain requirements demand a voltmeter with infinite impedance. For some purposes high sensitivity is necessary. Ruggedness is usually desirable. Flexibility is often the governing factor in choosing a meter.

Listed below are several meters designed for specific needs in the laboratory and in communications work.

The vacuum tube is used in the infinite-impedance meter since the grid-filament impedance is practically infinite until very high frequencies are reached, so long as the grid is maintained negative. The more common moving-coil and hot-wire instruments are made available to cover various ranges of sensitivity. The copper-oxide-rectifier unit has been adapted to several instruments and has proved very satisfactory over the audio-frequency range where the commercial dynamometer instruments fail. Used in the power-level indicator, it has provided a simplified method of measuring voice-power levels.

General Radio meters are described under the following six general headings:

- a) Thermionic Voltmeters
- b) Copper-Oxide-Rectifier Voltmeters
- c) Hot-Wire Meters
- d) Ohmmeters
- e) Output Meters and Power-Level Indicators
- f) Oxide Rectifiers and Thermocouples

THERMIONIC VOLTMETERS

THE vacuum tube lends itself particularly well to use as a voltmeter where no current may be taken by the instrument. In the TYPE 426-A Thermionic Voltmeter described below, all external circuits have been eliminated.

The plate-to-filament resistance of the three-element tube is used as one arm of a bridge circuit. Changes in the grid potential caused by the measured voltage cause changes in the value of this resistance, which unbalance the bridge. The amount of unbalance is indicated by a micro-ammeter. It therefore measures the potential impressed.

TYPE 426-A THERMIONIC VOLTMETER

Range: See price list.
Power Supply: 22.5-volt battery which supplies filament, grid and plate potentials.
Space provided in instrument case to accommodate two 22.5-volt batteries connected in parallel. External battery recommended, however. Connections provided. *Method of Calibration:* The meter is calibrated.

brated against root-mean-square values of a sinusoidal wave.

Accuracy of Calibration: Within 0.5 per cent. up to 1000 hours, at which time the instrument should be returned to the factory for a new tube and calibration. See price list.

Frequency Error: Less than 2 per cent. of full scale at 20 kc. Less than 3 per cent. at

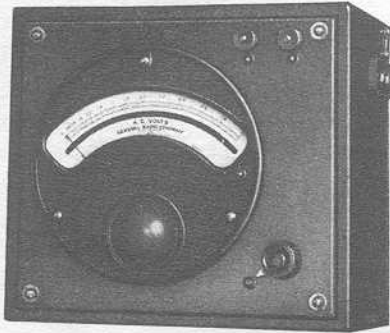

300 kc. Although calibration is not reliable at broadcast and higher radio frequencies, the voltmeter may be used for making voltage comparisons in that range.

Waveform Error: Slight when due to third harmonic. Appreciable when due to second harmonic. Second harmonic error can be almost wholly corrected by reversing the leads to the meter and averaging the two readings obtained.

Adjustment: With voltmeter terminals short-circuited, the meter pointer is set at zero by means of a rheostat mounted in the case.

Overvoltage: Will withstand 50 volts momentarily.

Tube: Special tube, similar in power requirements to 199-type, soldered in place.

Mounting: Polished walnut case.

Dimensions: 9 x 7 $\frac{3}{4}$ x 10 $\frac{1}{4}$ inches.

Weight: 11 pounds.

Type	Range	Code Word	Price
426-A	0-3 volts, r.m.s.	SERUM	\$160.00
	Recalibration, including replacement tube		20.00

COPPER-OXIDE-RECTIFIER VOLTMETERS

THESE instruments are designed for the measurement of alternating-current voltages at frequencies from 20 to 10,000 cycles per second. The indicating element consists of small copper-oxide units arranged in the form of a bridge for obtaining full-wave rectification. The alternating-current voltage applied to the input terminals of this type of structure results in a direct current through the meter circuit. The direct current is proportional to the root-mean-square value of the alternating voltage.

A change of impedance with applied voltage is a characteristic of all copper-oxide rectifiers, and hence it is desirable that some means be provided for maintaining the input impedance to this type of instrument at a constant value. In the two types listed below, the proper choice of resistances external to the indicating element has provided a suitable means for meeting this problem.

TYPE 427-F ALTERNATING-CURRENT VOLTMETER

THIS is a precision laboratory instrument of the portable type, having a high impedance. It consists of a rectifier unit working in conjunction with an accurately balanced d'Arsonval movement of the two-pivot type. The double-pivot movement is mounted on selected jewels. The large hand-drawn legible scale with mirror to prevent parallax, and with a knife-edge pointer, has 100 scale divisions, thus insuring accurate

COPPER-OXIDE-RECTIFIER VOLTMETERS

determinations. This instrument is particularly suitable for comparison methods because of the precision of reading.

Range: See price list.
Impedance: Approximately 2000 ohms per volt.

Length of Scale: 5½ inches.
Accuracy of Calibration: Within 2 per cent. of full-scale at frequencies up to 3000 cycles. Within 5 per cent. to 5000 cycles. Within 10 per cent. to 10,000 cycles.

Adjustment: A small screw is provided for making the zero adjustment.

Mounting: Polished walnut case, fitted with leather handle.

Dimensions: 3½ x 6½ or 7¼ inches.
Weight: 5½ pounds.

Type	Range	Code Word	Price
427-F	0-5 volts, r.m.s.	FAVNA	\$75.00

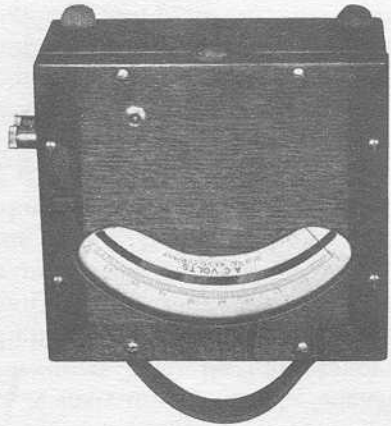

THIS instrument is of panel-mounting type and consists of a copper-oxide-rectifier meter in conjunction with a micro-ammeter. The scale has 30 divisions and the movement is of the d'Arsonval type.

TYPE 488-A ALTERNATING-CURRENT VOLTMETER

Range: See price list.

Impedance: When used for voltage determinations, impedance changes in the meter cause no appreciable error. Maintained approximately constant at 4000 ohms with 2 volts applied. In error 10 per cent. from 20 to 1000 cycles with 3 volts applied. In error 5 per cent. from 20 to 10,000 cycles with one volt applied.

Length of Scale: 2½ inches.
Accuracy of Calibration: Within 2 per cent. of its full-scale reading at frequencies up to 2000 cycles. Within 5 per cent. to 5000 cycles. Within 10 per cent. to 10,000 cycles.

Adjustment: A screw is provided under the glass face for making the zero adjustment. Glass face can be removed by unscrewing it from frame.

Mounting: Moulded bakelite case.

Dimensions: Diameter, 5½ inches; depth, 2¼ inches over all. Mounting hole diameter, 2 27/32 inches.
Weight: 12 ounces.

Type	Range	Code Word	Price
488-A	0-3 volts, r.m.s.	FELON	\$20.00



HOT-WIRE METERS

AN instrument for the measurement of currents at high frequencies must keep its inductance and capacitance as small as possible. High reactance would cause the readings to vary with frequency. For many radio-frequency measurements a suitably designed hot-wire ammeter has the necessary characteristics which particularly adapt it to this work. It should, however, be recognized that a hot-wire ammeter is inherently less accurate than an ammeter of the moving-coil type, which of course is unsuitable for measuring current at high frequencies. In the TYPE 127 Hot-Wire Meter, careful design and good workmanship have produced instruments which are electrically and mechanically rugged and reliable. These meters are used extensively in wavemeters for determining the resonance point and are also used for measuring the radiation, filament, and plate currents in experimental transmitting stations. They are equally suitable for use on direct and alternating current.

TYPE 127 HOT-WIRE METERS

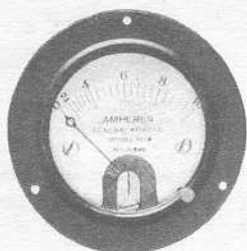

TYPE 127-A



TYPE 127-B



TYPE 127-C

FLUSH-MOUNTING MODELS

Range: See price list.

Resistance: See price list.

Scale Length: 2 inches.

Movement: Hot-wire type. The expanding strip is of a platinum-silver alloy, proportioned to work at a low temperature. Its low resistance permits reasonable overload and minimizes losses.

Adjustment: A knurled screw is provided for making the zero adjustment.

Dimensions: Diameter, $3\frac{3}{8}$ x 2 inches over all. Mounting hole diameter, $2\frac{5}{8}$ inches.

Weight: 8 ounces.

Type	Range	Approx. Resistance	Code Word	Price
127-A	100 milliamperes	23.0 ohms	MEDAL	\$6.00
127-A	250 "	8.5 "	MERCY	6.00
127-A	0.5 ampere	2.5 "	MERIT	6.00
127-A	1 "	0.9 ohm	MERRY	6.00
127-A	3 amperes	0.25 "	MIMIC	6.00
127-A	5 "	0.07 "	MINIM	6.00
127-A	10 "	0.052 "	MINNY	6.00
*127-A	270 milliamperes (approx.)	9.0 ohms	MITER	5.75

* When ordering, specify TYPE 127-A Galvanometer

(Continued on following page)

PANEL-MOUNTING MODELS

PANEL-MOUNTING models differ from other hot-wire meters only in the method of mounting. See the illustration.

Dimensions: 3 x 3 3/4 x 1 1/2 inches. Weight: 4 ounces.

Type	Range	Approx. Resistance	Code Word	Price
127-B	100 milliamperes	23.0 ohms	MAJOR	\$6.00
127-B	250 "	8.5 "	MADAM	6.00
127-B	0.5 ampere	2.5 "	MAJOR	6.00
127-B	1 "	0.9 ohm	MANOR	6.00
127-B	3 amperes	0.25 "	MASON	6.00
127-B	5 "	0.07 "	MATTN	6.00
127-B	10 "	0.052 "	MAXIM	6.00
127-B	270 milliamperes (approx.)	9.0 ohms	MAGIC	5.75

* When ordering, specify Type 127-B Galvanometer

CASE-MOUNTING MODELS

CASE-MOUNTING models differ from other models only in the method of mounting. See the illustration.

Dimensions: 3 x 3 x 2 1/2 inches over all. Weight: 6 ounces.

Type	Range	Approx. Resistance	Code Word	Price
127-C	100 milliamperes	23.0 ohms	MUGGY	\$6.50
127-C	250 "	8.5 "	MOCHA	6.50
127-C	0.5 ampere	2.5 "	MOGUL	6.50
127-C	1 "	0.9 ohm	MOIAR	6.50
127-C	3 amperes	0.25 "	MORAL	6.50
127-C	5 "	0.07 "	MUMMY	6.50
127-C	10 "	0.052 "	MUSTY	6.50
127-C	270 milliamperes (approx.)	9.0 ohms	MOTTO	6.25

* When ordering, specify Type 127-C Galvanometer

OHMMETERS

HERE are many occasions in laboratories, service stations, and factories when an approximate measurement of resistance is required. The Type 287 Direct-Reading Ohmmeter is designed for simplifying the determination of resistance where an approximate value is sufficient.

TYPE 287 DIRECT-READING OHMMETER

THIS instrument consists of a battery and meter in series with a resistance, and a rheostat shunted across the meter to provide a zero adjustment. The dial is calibrated directly in ohms. Clip leads are provided for convenience in connecting the ohmmeter to the device to be measured.

Range: See price list.

Operation: Before using the ohmmeter, the zero should be checked by connecting the terminals together and adjusting the knob until the meter registers zero resistance. The short-circuiting connection is then removed and the meter is ready for use.

Battery: A 4.5-volt battery for TYPE 287-A and a 1.5-volt battery for TYPE 287-B are furnished with the instrument.

Mounting: Polished walnut. Leather strap provided for carrying.

Dimensions: $6\frac{3}{4} \times 5\frac{3}{4} \times 4\frac{1}{2}$ inches.

Weight: $2\frac{1}{2}$ pounds.

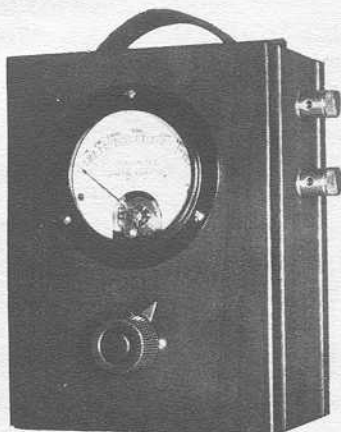

TYPE 287-A

Type	Range	Code Word	Price
287-A	0-10,000 ohms, 500 ohms, center-scale	ONION	\$30.00
287-B	0- 2000 " , 100 " , " "	ORBIT	30.00

OUTPUT METERS AND POWER-LEVEL INDICATORS

UNTIL the development of copper-oxide-rectifier-type meters, the vacuum-tube voltmeter was practically the only instrument suitable for making voltage measurements over the audio-frequency spectrum. It has the obvious disadvantage of requiring tubes and batteries, both of which require frequent replacement and limit the portability of any instrument in which they are used.

The two instruments described in this section, an output meter and a power-level indicator, make use of the copper-oxide-rectifier voltmeter for the measurement of voice-frequency power. The output meter consists of a 0-3-volt voltmeter and a network for extending its range to 150 volts. Since the input impedance remains practically constant at 4000 ohms regardless of frequency and setting of multiplier, it furnishes a convenient means of measuring the power output of a radio receiver.

The power-level indicator is similar to the output meter, except that the voltmeter and the multiplier network are calibrated in decibels. It is useful for monitoring as well as measuring the voice-power level in all kinds of transmission and recording circuits.

TYPE 486 OUTPUT METER

THIS instrument, designed primarily to measure the output power of any device operating over the frequency range of from 20 to 10,000 cycles per second, is admirably adapted for use as a general-purpose multirange alternating-current voltmeter. It consists of an indicating meter preceded by a suitable multiplier for extending the range of the instrument. The multiplier unit, essentially an L-type attenuator, maintains the input impedance of the instrument at 4000 ohms, thus simulating the impedance of the usual cone speaker. It was designed primarily for determining the power output of radio sets. Its uses are many. In the laboratory it is readily available for determining line voltage, as well as for measuring the voltage applied to the filaments of alternating-current tubes.

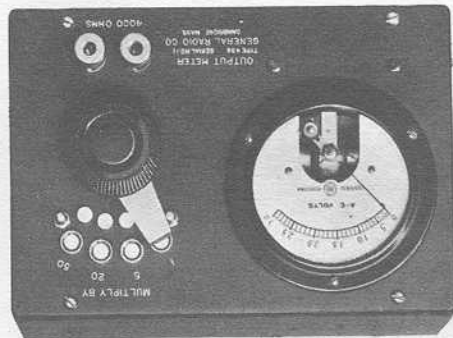

Range: See price list.
Impedance: With multiplier set at 1, the impedance is the same as for the TYPE 488-A Alternating-Current Voltmeter described previously. With multiplier set at 5, 20, or 50, the impedance is 4000 ohms ± 2 per cent, and is non-reactive.
Scale Length: 2 1/2 inches.
Accuracy of Calibration: Same as TYPE 488-A Alternating-Current Voltmeter.
Adjustment: Zero adjustment same as for TYPE 488-A model.
Mounting: Polished walnut case.
Dimensions: 7 3/8 x 5 x 3 1/2 inches.
Weight: 2 1/2 pounds.

Type	Range	Code Word	Price
486	0-3-15-60-150 volts across 4000 ohms, or 5.6 watts, max.	MALAY	\$88.00

TYPE 586 POWER-LEVEL INDICATORS

THE importance of maintaining a careful check upon the signal amplitude at various points in voice-transmission circuits is well recognized by acoustic engineers. Too low a level means interference from background noises; too high a level means overloading of amplifiers and reproducers and the introduction of near-by channels. The TYPE 586 Power-Level Indicator has many advantages for work of this kind. It is portable, compact, rugged, accurate, low in price, and requires no batteries or re-placements.

This instrument always presents a purely resistive load to the line, thus eliminating all possibility of changing the frequency characteristics of the line. The moving element, slightly damped to prevent any undue overthrow on sudden surges, is particularly rugged and will withstand the hard usage attendant upon maintaining a continuous check on the rapidly changing power level of voice circuits. Between the input terminals and the indicating voltmeter is inserted an adjustable L-type attenuation network which serves as a multiplier for increasing the range while maintaining the input impedance constant regardless of setting. The power level in decibels is obtained by taking the sum of the reading of the multiplier switch and the meter reading.

CABINET MODEL

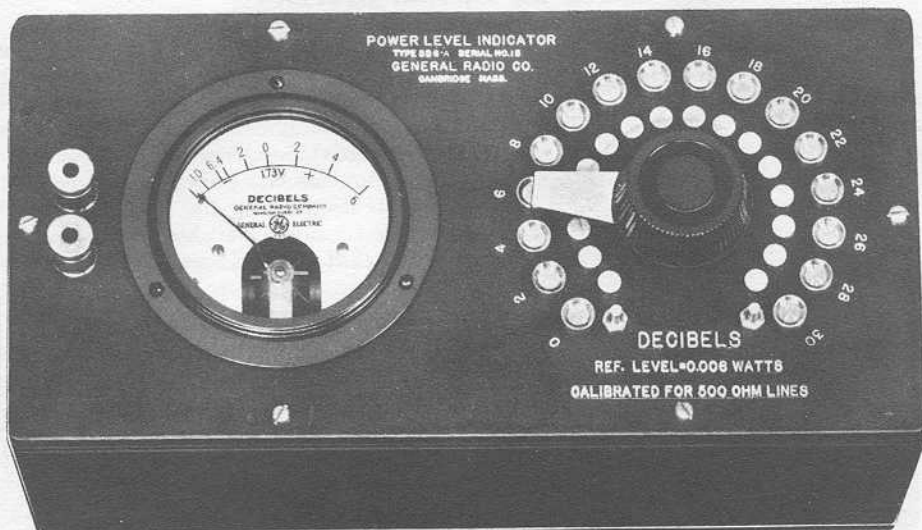

TYPE 586-A

Range: See price list.

Impedance: 5000 ohms.

Scale Reading: Zero level at mid-scale. This corresponds to 6 milliwatts or 1.73 volts when connected across a 500-ohm line. Graduated in steps of 2 decibels to cover the range from -10 to +6 decibels. Network adjustable in steps of 2 decibels.

Indicating Element: Copper-oxide-rectifier voltmeter calibrated to read power level in decibels.

Accuracy: Slight variation in oxide-rectifier impedance with current passing through introduces a small error. Effect greatest at -10-decibel mark on meter where the reading may be 0.5 decibel low.

Average error is from 0.1 to 0.2 decibel, entirely negligible. No appreciable frequency error up to 10,000 cycles per second.

Uses: Monitoring the power level of a voice circuit. Power and voltage measurements. Amplifier gain and circuit loss determinations. Equalization measurements on voice circuits.

Calibration: Calibrated to read directly when across a 500-ohm line. Constant correction term taken from a correction chart furnished with the instrument must be applied when instrument is used across lines of impedance other than 500 ohms.

Dimensions: 10 x 5 x 5 inches.

Weight: 2 $\frac{7}{8}$ pounds.

Type	Range	Dimensions	Weight	Code	Price
586-A	-10 db to +36 db with zero level at 0.006 watts and 500-ohm line.....	10 x 5 x 5 in.	2 $\frac{7}{8}$ lb.	HABIT	\$60.00

RELAY-RACK MODEL

THIS model is identical with the cabinet model except for the method of mounting. It is arranged for mounting on a standard 19-inch relay rack. It has a $\frac{1}{4}$ -inch bakelite panel and is protected by a dust cover of nickel-plated brass.

WHEN the power-level indicator is used on recording circuits, it is sometimes desirable to have an auxiliary meter located at a distance from the point where the instrument is installed. This enables a second operator to keep in touch with what is going on in the recording circuit.

So that this can be done, all rack-mounting models (TYPE 586-B) are provided with an extra pair of terminals to which the external meter may be connected. These terminals

are in series with the d'Arsonval movement of the meter in the power-level indicator and are bridged by a short-circuiting strap when not in use. The TYPE 586-P3 Meter described in the following section is intended for use as the external meter.

The insertion of the external meter will cause no appreciable error in the reading of the power-level indicator. Pickup is usually the factor that limits the distance at which the extra meter may be placed.

Dimensions: 19 x 5 $\frac{1}{4}$ x 5 inches.
Weight: 4 pounds.

Type	Range	Dimensions	Weight	Code	Price
586-B	-10 db to +36 db with zero level at 0.006 watts and 500-ohm line.....	19 x 5 $\frac{1}{4}$ x 5 in.	4 lb.	HANDY	\$64.00

TYPE 586-P ACCESSORIES

THE TYPE 586-P1 Meter is a copper-oxide-rectifier voltmeter, identical with the indicating element in the TYPE 586-A Power-Level Indicator. It has a range of -10 db to +6 db with zero level at 0.06 watts on a 500-ohm line. It does not have the extra terminals for connecting in an external meter.

The TYPE 586-P3 Meter is similar to the TYPE 586-P1 Meter except that it is the d'Arsonval movement only, without an oxide rectifier. It is intended as the external meter for use with the TYPE 586-B Power-Level Indicator.

The following data apply to both meters:

Dimensions: Diameter, 3 $\frac{1}{2}$ inches; depth, 2 $\frac{1}{4}$ inches over-all. Mounting hole diameter, 2 $\frac{1}{8}$ inches.
Weight: 12 ounces.

Type	Code Word	Price
586-P1	POWLEVGOAT	\$20.00
586-P3	POWLEVMIK	18.00

OXIDE RECTIFIERS AND THERMOCOUPLES

THIS chapter describes for the first time two new elements for electric measuring circuits: the TYPE 492-A Oxide Rectifier and the TYPE 493 Thermocouples. They are intended for use with the user's own meters, a wide variety of suitable types being commercially available.

TYPE 492-A OXIDE RECTIFIER

THE TYPE 492-A Oxide Rectifier is provided for use with relays and direct-current indicating instruments on alternating-current service. The unit is at present offered primarily for experimental use and the following specifications are indicative rather than positive.

It must be realized that the copper-oxide type of rectifier is subject to changes in both sensitivity and frequency characteristics with output load. The sensitivity also varies with impressed voltage. The values given below approximate those obtained under usual conditions of voltage and load.

This rectifier unit is made for us by the General Electric Company.

Frequency Error: The rectifier may be used without appreciable frequency error at frequencies below 5000 cycles per second.

Temperature Error: Temperature errors of about 5% may be expected between normal extreme temperatures. Maximum sensitivity is obtained with a load of 5000 to

7000 ohms. This value should be used when the instrument is operating a relay. If a 200-milliamperere micro-ammeter of about 500 ohms resistance is used, full-scale deflection will be obtained at about 2 volts across the rectifier input.

The maximum current output from the

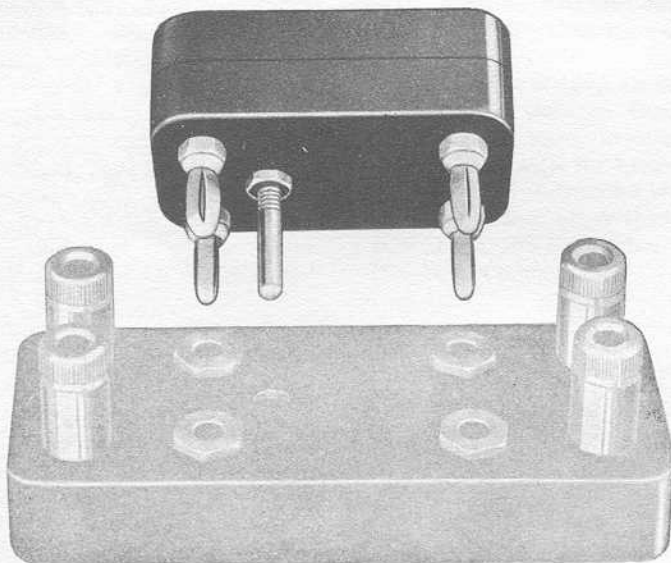

Mounting case for TYPE 492-A Oxide Rectifier and TYPE 493 Thermocouples with TYPE 274-RJ Mounting Base

rectifier should not exceed 15 milliamperes, nor should the impressed voltage exceed 3 volts. Obviously, the apparent change of impedance with resistance can be greatly reduced by proper use of series and shunt resistance on the input side.

Dimensions: Size of case, exclusive of plugs, $2\frac{1}{8} \times 1\frac{3}{8} \times \frac{3}{4}$ inches. *Weight:* 4 ounces.

Type	Code	Price
492-A	FLORA	\$7.00

TYPE 493 THERMOCOUPLES

While indicating direct-current instruments can be made for currents as low as a few micro-amperes, dynamometer instruments for the measurement of alternating currents are not available in low ranges due to the inherent low efficiency of this type of instrument.

In the measurement of alternating currents of small magnitudes the heating effect of the current is generally utilized. In the thermocouple the heat caused by the flow of current through a wire is applied to a junction of dissimilar metals. Such a junction sets up a direct-current voltage which actuates a sensitive direct-current indicating meter. This type of instrument is a true integrating ammeter, since the direct-current meter reading is a function of average squared current in the heater. A thermocouple is, therefore, independent of waveform errors. Frequency errors occur only at frequencies so high that the shunting effect of stray capacitances in the couple mounting becomes significant.

Construction: The thermo-junctions used in the Type 493 Thermocouples are mounted in an evacuated glass bulb. The vacuum serves to provide radiation of heat from the couple and also reduces the effect of external temperature variations. The glass bulb is surrounded by felt and mounted in a bakelite container, fitted with plugs for plugging into a Type 274-RJ Mounting Base (see page 54). The thermo-junction is in direct contact with the heater wire.

The Type 493 Thermocouples are suitable for use on either alternating or direct current. Reversed readings are desirable in making calibrations although reversal will not ordinarily change the indication by more than one-tenth millivolt.

Construction: The thermo-junctions used in the Type 493 Thermocouples are mounted in an evacuated glass bulb. The vacuum serves to provide radiation of heat from the couple and also reduces the effect of external temperature variations. The glass bulb is surrounded by felt and mounted in a bakelite container, fitted with plugs for plugging into a Type 274-RJ Mounting Base (see page 54). The thermo-junction is in direct contact with the heater wire.

The Type 493 Thermocouples are suitable for use on either alternating or direct current. Reversed readings are desirable in making calibrations although reversal will not ordinarily change the indication by more than one-tenth millivolt.

Type	Heater Resistance	10 millivolts Open Circuit	Current to Give Maximum Safe Current	Code	Price
493-A	0.5 ohms	275 ma.	415 ma.	FUNNY	\$12.00
493-C	2	100 ma.	150 ma.	FOCUS	12.00
493-E	10	25 ma.	45 ma.	FOLLY	12.00
493-H	100	8 ma.	12 ma.	FORAY	12.00
493-K	450	4.5 ma.	7 ma.	FORUM	12.00

RELAYS, SWITCHES, AND MISCELLANEOUS ACCESSORIES

CAREFULLY designed and well made accessories are essential in all kinds of experimental work around the laboratory. The General Radio Company has always given due attention to its line of accessories and several new items are added each year.

Particular attention is directed to the section which describes the TYPE 274 Jacks, Plugs and Mounting Bases. They offer limitless possibilities.

RELAYS

TYPE 481 POLAR RELAY

THIS relay has a permanent horseshoe magnet which provides the field and at the same time forms a protecting shield about the coil and reed. An unusual feature is the wide separation between the pole pieces (0.47 inch) which provides a uniform magnetic field in the region through which the reed moves. It also makes the neutral position less critical.

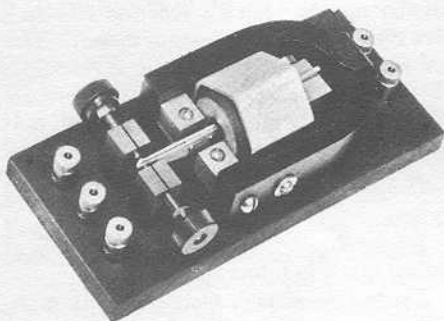

Operating Characteristics: See price list.

Current-carrying Capacity: The contact points are rugged and will break one ampere without undue burning.

Dimensions: 6 x 2 x 1 inches.

Weight: 2¼ pounds.

Type	Resistance	Normal Operating Current	Maximum Frequency	Code Word	Price
481	1500 ohms	2 milliamperes	125 cycles/second	NOMAD	\$20.00

TYPE 507 NON-POLAR RELAY

THESE relays contain an armature which has no permanent magnetization and which will not therefore distinguish between the direction of current flow.

Sensitivity: See price list. Values given are for currents corresponding to positive operation in either vertical or horizontal positions.

Resistance: Held to within ±10 per cent.

Dimensions: 4½ x 3 x 2 inches.

Weight: 1 pound.

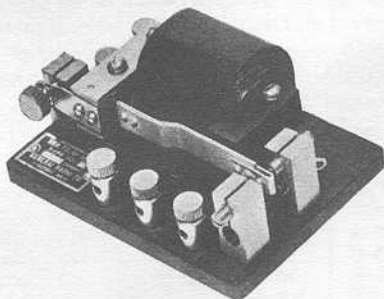

Type	Resistance	Current to close	Current to open	Code Word	Price
507-A	250 ohms	10 milliamperes	6 milliamperes	NITRE	\$12.00
507-B	4000 "	2 "	1 milliampere	NOBLE	15.00

KNOB AND DIALS

TYPE 318 DIAL PLATE

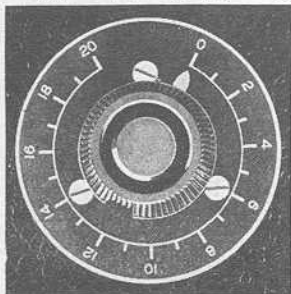

TYPE 214 RHEOSTAT AND TYPE 318 DIAL PLATE, SHOWING METHOD OF MOUNTING

THE TYPE 318 Dial Plate is a photo-etched metal scale with raised nickel-silver markings on a flat black back-ground. It carries twenty divisions equally spaced around an arc of 303°, one inch in radius, and it is intended for use with General Radio Type 214 and Type 371 Rheostats and Potentiometers. The same three machine screws which hold the rheostat or potentiometer to the panel will hold the Type 318 Dial Plate in position. The accompanying illustration shows the dial plate and a Type 214 Rheostat mounted on a panel.

Dimensions: Diameter, 3 inches. Weight: 1 ounce.

Type	Code Word	Price
318	DEVIL	\$0.35

TYPE 310 AND TYPE 317 DIALS

THESE dials meet the most rigid requirements for an inexpensive dial by means of which settings may be duplicated with precision. Fine markings facilitate accurate settings, and, since indicator and dial are both in the same plane, there is no parallax. Type 310 Dials have a diameter of $2\frac{3}{4}$ inches; the Type 317 Dials have a diameter of $4\frac{1}{2}$ inches.

Markings are etched in permanent black on the dull polished surface of the $1/32$ -inch nickel-silver dial plate. Type 310 Dials have 100, Type 317 Dials have 200 individual graduations equally spaced around an arc of 180° or 270° as specified in the following data table. The table also lists the diameter as well as the maximum and minimum distances that the shaft may extend beyond the front of the panel. The column "Knob Type" refers to the type number of the knob furnished with the dial.

The Type 310 and Type 317 Dials are equivalent, respectively, to the Type 502 and Type 503 Dials described in the following section except that the former have no friction drives. A good idea of their appearance, method of mounting the indicators, and fineness of the graduations can be gained from the illustration. The indicator rides the edge of the dial even if the shaft be slightly out of true. An indicator, a machine screw and nut for fastening it, and a drilling template are packed with each dial.

Type	Diameter	Arc	Knob Type	Shaft Diameter	Shaft Length	Weight	Code Word	Price
310-A	$2\frac{3}{4}$ in.	180°	137-D	$1\frac{1}{4}$ in.	$1\frac{1}{2}$ - $\frac{3}{4}$ in.	2 oz.	DIZZY	\$0.80
310-G	$2\frac{3}{4}$ in.	270°	137-D	$1\frac{1}{8}$ - $\frac{3}{4}$ in.	$1\frac{1}{2}$ - $\frac{3}{4}$ in.	2 oz.	DEMYR	0.80
317-A	4 in.	180°	137-H	$1\frac{1}{4}$ in.	$\frac{5}{8}$ - $\frac{7}{8}$ in.	4 oz.	DONOR	1.50
317-B	4 in.	270°	137-H	$1\frac{1}{4}$ in.	$\frac{5}{8}$ - $\frac{7}{8}$ in.	4 oz.	DOWDY	1.50
317-F	4 in.	180°	137-H	$\frac{5}{8}$ in.	$\frac{5}{8}$ - $\frac{7}{8}$ in.	4 oz.	DOWEL	1.50
317-G	4 in.	270°	137-H	$\frac{5}{8}$ in.	$\frac{5}{8}$ - $\frac{7}{8}$ in.	4 oz.	DRAMA	1.50

TYPE 502 AND TYPE 503 DIALS

THE TYPE 502 and TYPE 503 Dials are, respectively, the new TYPE 310 and TYPE 317 Dials equipped with a simple but effective slow-motion control. The dials and indicators are identical with the corresponding TYPE 310 and TYPE 317 Dials previously described.

The slow-motion device was originally designed for use on our line of laboratory measuring instruments, but we are offering it for general use in the belief that its ruggedness and simplicity will appeal to laboratory workers and amateurs. It is easy to mount, a center punch and a 7/16-inch drill being the only tools required. It is so designed that it in no way interferes with the mounting of the dial. Adjustments on the friction drive can be made without disturbing the calibration of the instrument to which the dial is attached.

Beneath the face of the dial is mounted a disc of slightly smaller diameter which is gripped by a friction wheel attached to the slow-motion drive knob. The friction-drive shaft is carried in a bushing inserted in the panel. The shaft hole in the bushing is slightly eccentric with respect to the center of the hole holding the bushing, thus affording a simple means of adjusting the amount of friction between the friction wheel and the disc behind the dial.

The TYPE 502 and TYPE 503 Dials are supplied complete with friction drive, indicator, indicator fastening screw and nut, and drilling template.

Type	Dial		Shaft Diameter	Dial Type	Approx. Reduction Ratio	Weight	Code Word	Price
	Diameter	Arc						
502-A	2 $\frac{3}{4}$ in.	180°	1/4 in.	310-A	1:3.3	3 oz.	DRUID	\$1.50
502-F	2 $\frac{3}{4}$ in.	180°	3/8 in.	310-F	1:3.3	3 oz.	DYING	1.50
502-G	2 $\frac{3}{4}$ in.	270°	3/8 in.	310-G	1:3.3	3 oz.	DAILY	1.50
503-A	4 in.	180°	1/4 in.	317-A	1:5	6 oz.	DRYAD	2.00
503-F	4 in.	180°	3/8 in.	317-F	1:5	6 oz.	DUCAT	2.00
503-G	4 in.	270°	3/8 in.	317-G	1:5	6 oz.	DUMMY	2.00

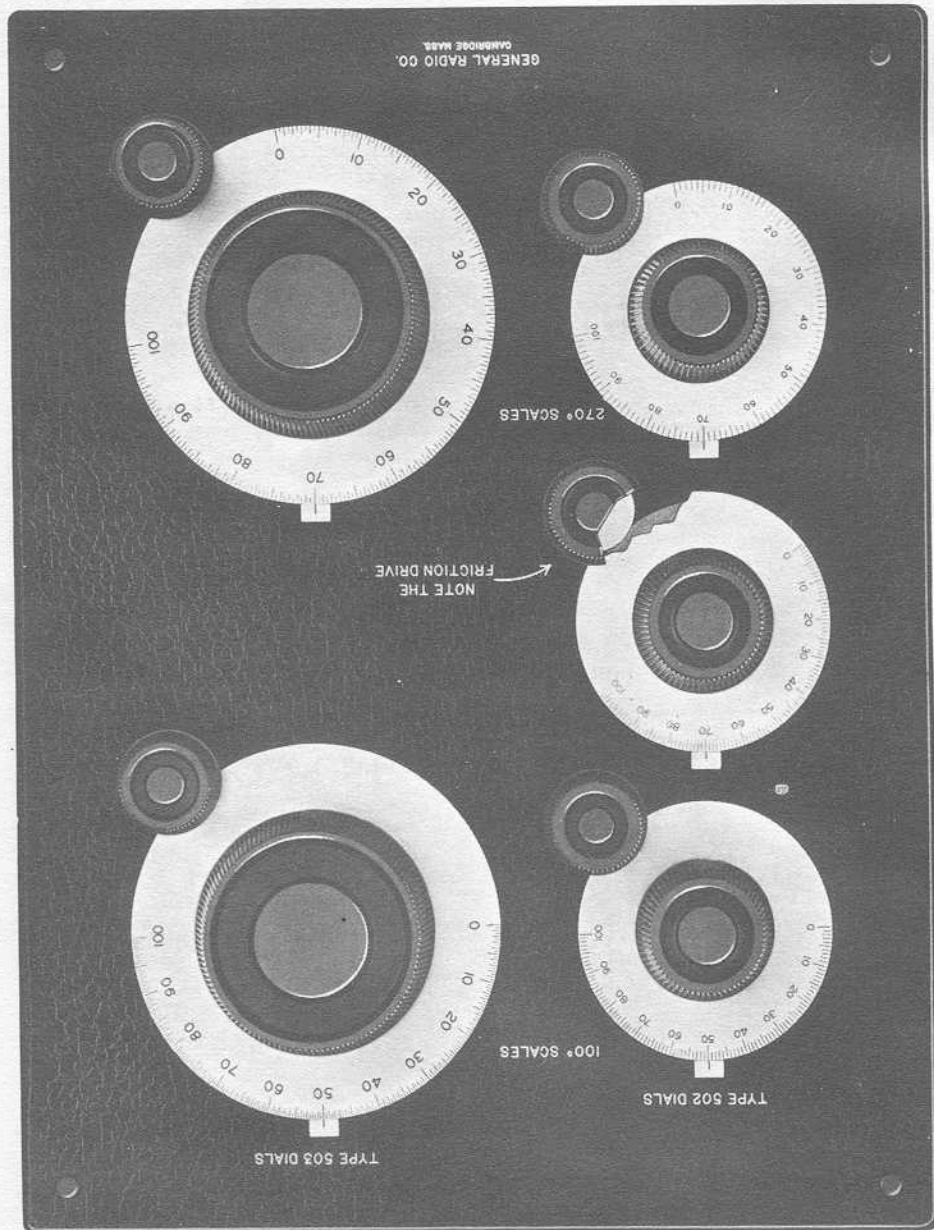

TYPE 137 KNOBS

THESE are shown half-size in the photographs on page 49. They are made of moulded bakelite with inserts of brass, and all but the TYPE 137-K Knob are furnished with a single setscrew.

Type	Shaft	Diameter	Height	Weight	Code Word	Price
137-D	With Pointer	¼ in.	1½ in.	5/8 in.	2 oz.	STANNOBANT \$0.30
137-D	Without	¼ in.	1½ in.	5/8 in.	1 oz.	STANNOBUG .25
137-H	Without	¼ in.	25/8 in.	7/8 in.	1 oz.	STANNOBCAT .50
137-J	With	¼ in.	1½ in.	½ in.	1 oz.	STANNOBDOG .20
137-J	Without	¼ in.	1½ in.	½ in.	1 oz.	STANNOBEYE .15
137-K	Without	10-32	13/16 in.	7/16 in.	1 oz.	STANNOBFAD .15
137-L	With	¼ in.	1 11/16 in.	7/8 in.	1 oz.	STANNOBGAS .20

BINDING POSTS, SWITCH CONTACTS, AND STOPS

ALL of these items are used on General Radio instruments. The TYPE 138-V and TYPE 138-X Binding Posts are recessed to receive a TYPE 274-P Plug. They are extremely useful for use on portable instruments in the laboratory.

TYPE 138 BINDING POSTS, SWITCH CONTACTS, AND SWITCH STOPS

THE dimensions of these accessories are given in the price list. They are shown half-size in the photographs on page 49.

BINDING POSTS

Type	Material	Diameter	Height	Max. Panel Thickness	Thread	Code Word	Price
138-A	Bakelite and N.P. Brass	¾ in.	5/8 in.	3/8 in.	10-32	STANPARCUP	\$0.18
138-W	Nickel-Plated Brass	7/16 in.	13/32 in.	¼ in.	6-32	STANPARCAP	0.08
*138-V	" " "	3/8 in.	11/16 in.	3/8 in.	10-32	STANPARANT	0.20
*138-X	" " "	½ in.	11/16 in.	3/8 in.	10-32	STANPARBOY	0.20
138-Y	" " "	½ in.	¾ in.	¼ in.	10-32	STANPARMIK	0.14
138-Z	" " "	3/8 in.	5/8 in.	¼ in.	6-32	STANPARHIT	0.07

* See also, TYPES 274-K and 274-L Binding Post Assemblies

SWITCH CONTACTS

Type	Material	Diameter	Height	Max. Panel Thickness	Thread	Code Word	Price
138-B	Nickel-Plated Bronze	¼ in.	0.190 in.	5/16 in.	6-32	CONTACTANT	\$0.04
138-C	" " "	5/16 in.	0.190 in.	7/16 in.	6-32	CONTACTBUG	0.04
138-D	" " "	3/16 in.	0.195 in.	7/16 in.	CONTACTCAT	0.03

SWITCH STOPS

Type	Material	Diameter	Height	Max. Panel Thickness	Thread	Code Word	Price
138-Q	Nickel-Plated Brass	½ in.	7/8 in.	5/16 in.	6-32	STANPARBUL	\$0.04

(ONE-HALF SCALE)

BINDING POSTS

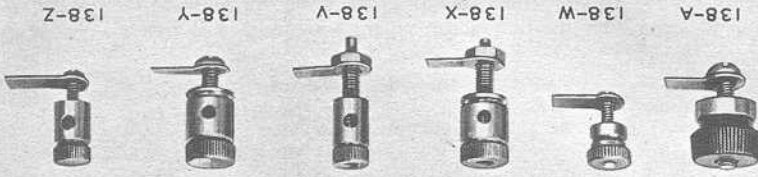

SWITCH CONTACTS



SWITCH STOPS



SWITCHES



KNOBS

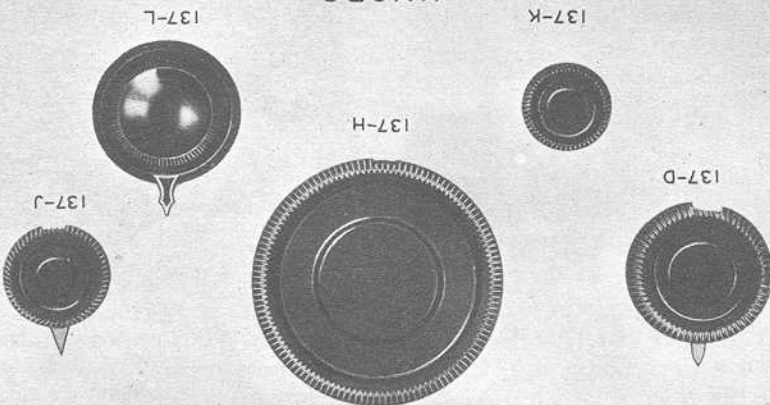

SWITCHES

THE three single-blade switches described in this section are all used in various General Radio instruments. The TYPE 337 Switches are useful around the laboratory and fit in well with the TYPE 274 Plugs.

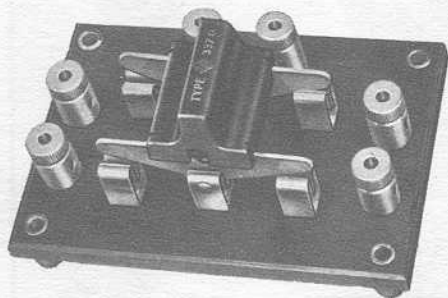

TYPE 337-A

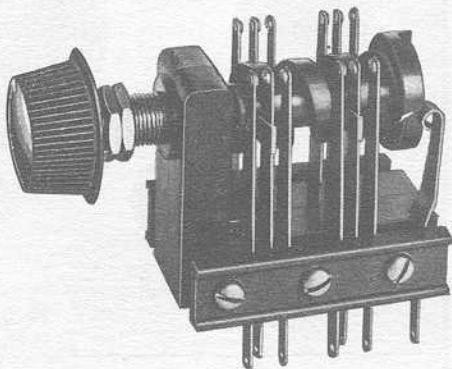

TYPE 339-A

TYPE 337 SWITCHES

THE experimenter will find the TYPE 337 Switches extremely convenient. The construction is such that a quick change-over may be effected.

Type	Description	Weight	Panel Size	Code Word	Price
337-A	2 Pole Double Throw	½ lb.	4 in. x 2¾ in.	SWITCHFROG	\$3.00
337-B	4 Pole Double Throw	1 lb.	6¾ in. x 5 in.	SWITCHGOAT	7.00
337-C	6 Pole Double Throw	1½ lb.	6¾ in. x 6¾ in.	SWITCHBIRD	10.00

TYPE 139 AND TYPE 202 SWITCHES

THESE are shown half-size in the photographs on page 49. The blades are of nickel-silver which, with bronze contact points, make for a minimum of cutting. Knobs are of moulded bakelite.

Type	Radius	Max. Panel Thickness	Knob	Over all Axial Length	Weight	Code Word	Price
139-A	1⅜ in.	5/16 in.	137-D	2 in.	¼ lb.	SWITCHFORD	\$0.50
202-A	1⅜ in.	5/16 in.	2 in.	⅜ lb.	SWITCHTOAD	0.75
202-B	1⅜ in.	⅜ in.	2 in.	⅜ lb.	SWITCHGOOD	0.75

TYPE 339 SWITCHES

THIS switch consists of a moulded bakelite bracket which carries the bushing for the switch shaft. The moving poles of the switch are controlled by the worm, one-quarter of a turn of which will make the contacts close.

Knob: Special. See illustration.

Mounting: Entire switch supported from panel by the bushing.

Dimensions: Those given in price list are over all. Shaft, ¼ inch.

Weight: 6 ounces.

Type	Description	Dimensions	Code Word	Price
339-A	4 Pole Double Throw	3 x 2 inches	PUPPY	\$2.50
339-B	2 Pole Double Throw	3 x 2 inches	PUPPY	2.00

VACUUM-TUBE SOCKETS

IN the design of all General Radio vacuum-tube sockets, care has been taken in each case to see that they meet all size requirements of the tubes with which they are to be used.

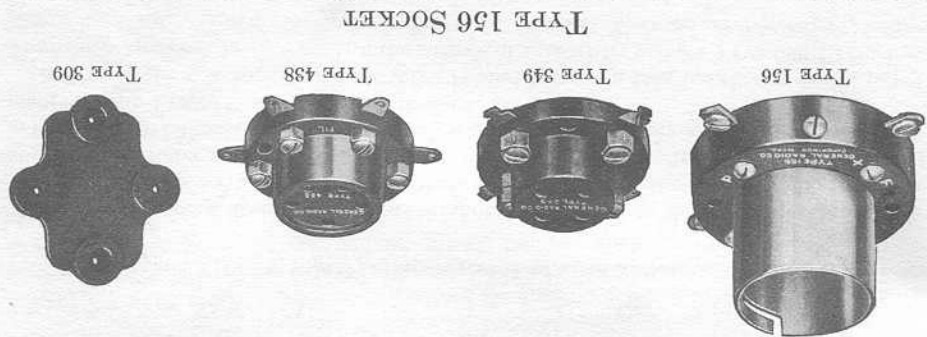

TYPE 156 SOCKET
 THIS is designed for tubes having the large UV- or UX-base. If desired, the location of the shell and its bayonet holder may be shifted through 45° for use with Western Electric Company's "E"-tubes.
 The phosphor-bronze contact springs are arranged to make positive contact on the sides of the tube prongs.

Type	Base	Diameter	Height	Weight	Code Word	Price
156	UX and W.E. "E"-tube	2 7/16 in.	1 3/16 in.	1/4 lb.	SOBER	\$0.75

TYPE 349 AND TYPE 438 SOCKETS

THE TYPE 349 socket is designed for the UX-type of tube; the TYPE 438 Socket is designed for the UY-type (5-prong) base. Positive contacts are made with double-gripping springs to the sides of the tube prongs.

Type	Base	Diameter	Height	Weight	Code Word	Price
349	UX	1 7/8 in.	3/4 in.	1/8 lb.	SEDAN	\$0.35
438	UY	1 7/8 in.	3/4 in.	1/8 lb.	STUDY	.35

TYPE 309 SOCKET CUSHION

MANY of the undesirable noises heard in a radio set are due to microphonic action of the tubes. This condition may be somewhat reduced by the use of this sponge-rubber socket cushion. It fits all General Radio sockets.

Type	Code Word	Price
309	SABER	\$0.25

TYPE 638 AND TYPE 649 SOCKETS

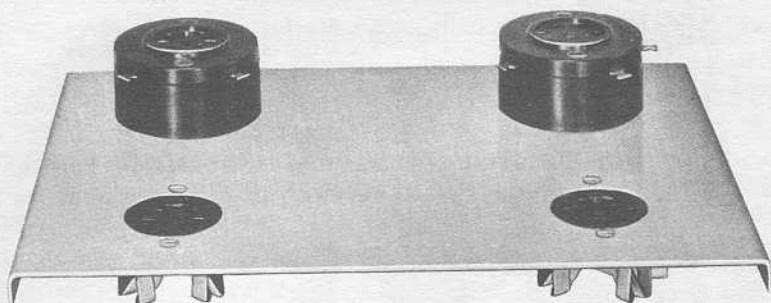

TYPE 649 (left) and TYPE 638 (right) Sockets mounted with and without the socket-mounting rings

THESE have been designed for general laboratory use where sockets even more sturdy than the TYPE 438 and TYPE 349 Sockets are required. The contact springs are made of phosphor bronze, specially tempered and shaped to resist fatigue. The mounting holes in the moulded bakelite bases are arranged so that the new sockets may be used as replacements for the TYPE 438 and TYPE 349 Sockets.

Ordinarily the new sockets are mounted behind holes in a thin bakelite or metal panel. They may, however, be mounted on the surface of a panel by using a TYPE 638-P1 Socket-Mounting Ring. The ring is required when the new sockets are used as replacements for the TYPE 438 and TYPE 349 Sockets.

Dimensions: "Diameter," given in price list is actual diameter of base exclusive of terminals. When socket is mounted behind

panel: diameter of hole in panel is $1 \frac{3}{16}$ inches; contact springs extend $\frac{13}{16}$ inch behind panel.

Type	Base	Diameter	Weight	Code Word	Price
638	UY—5-prong	2 in.	1 oz.	ALLOT	\$0.50
649	UX—4-prong	2 in.	1 oz.	ALOFT	0.45

TYPE 638-P1 SOCKET-MOUNTING RING

THIS is a bakelite ring for use with either the TYPE 638 or the TYPE 649 Socket as described on the preceding page. When the socket is so mounted, its upper surface is raised $1 \frac{1}{32}$ inches above the panel surface.

Type	Weight	Code Word	Price
638-P1	$\frac{1}{2}$ oz.	ALONE	\$0.15

TYPE 656, TYPE 657, AND TYPE 658 SOCKETS

BY special arrangement with the Isolantite Company of America we are listing the equivalent of our TYPE 156, TYPE 349, and TYPE 438 Sockets with glazed isolantite bases. The new sockets are designated, respectively, TYPE 656, TYPE 657, and TYPE 658.

Isolantite is an insulating material similar in appearance to white porcelain. The manufacturer claims that it is non-porous, that the dielectric losses are unusually low at very high frequencies, and that it has a low surface conductivity. The latter is a desirable feature in sockets that are to be used with photo-electric cells and their associated amplifiers.

The TYPE 656 Socket has a metal shell and is suitable for mounting 4-prong tubes either with or without the bayonet lock. If desired, the location of the bayonet lock may be

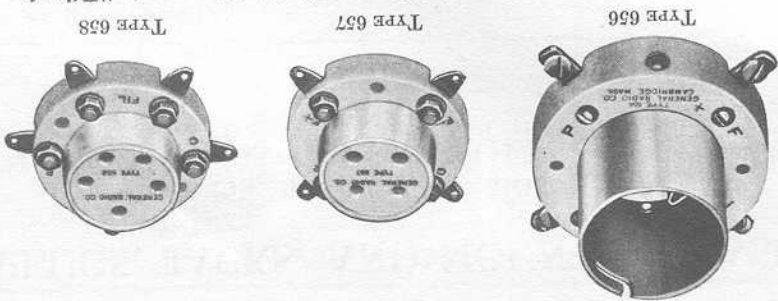

shifted through 45° to accommodate the Western Electric Company's "E" tube. The Type 657 and Type 658 Sockets are similar to the Type 549 and Type 438 Sockets. Positive contact with the sides of the tube prongs is insured by double-gripping springs. Both sockets have the raised ring around the top for guiding the prongs when inserting a tube.

Dimensions: "Diameter" given in price list is actual diameter of the base exclusive of terminals. "Height" in the following list

Type	Base	Diameter	Height	Weight	Code	Price
656	UX and W.E. "E"-tube	2 7/16 in.	1 27/32 in.	4 oz.	SOLD	\$1.50
657	UX—4-prong	1 7/8 in.	1 5/16 in.	2 oz.	AMAZE	1.50
658	UY—5-prong	1 7/8 in.	1 5/16 in.	2 oz.	AMONG	1.50

PORCELAIN INSULATORS

CAREFULLY glazed porcelain is an extremely satisfactory insulator for high-voltage, high-frequency work.

TYPE 260 AND TYPE 280 PORCELAIN INSULATORS

THE TYPE 280 Strain Insulator will be found particularly useful for antenna installations. The TYPE 260 Wall Insulator is equipped with a threaded brass rod at its upper end so that it may be used for supporting wiring or instruments as well as lead-in and ground wires.



Type	Description	Code Word	Price
260	Wall Insulator	CONIC	\$0.20
280	Strain Insulator	CUTLER	.12

PLUGS, JACKS, AND MOUNTING BASES

TYPE 274 PLUGS, JACKS, AND MOUNTING BASES

ALL of the devices listed in this section are built up from various combinations and modifications of the TYPE 274-P Plug and the TYPE 274-J Jack.

PLUGS			
Type	Description	Code Word	Price
274-P	Single Plug (Basic Unit)	STANPARCAT	\$0.06
274-E	Single Plug with Jack Shank	STANPARDOG	.20
274-D	Single Insulated Plug with Jack Shank	STANPAREYE	.25
274-G	Open-Type Double Plug with Jack Shanks	STANPARPIG	.50
274-M	Insulated Double Plug with Jack Shanks	STANPARBUG	.40

JACKS			
Type	Description	Code Word	Price
274-J	Single Jack (Basic Unit)	STANPARTOP	\$0.05
274-T	Double Adjustable Jack	STANPARTIP	.50

MOUNTING BASES			
Type	Description	Code Word	Price
274-AP	2-Gang Plug Base	STANPARBIB	\$0.50
274-AJ	2-Gang Jack "	STANPARHUM	.50
274-BP	3-Gang Plug "	STANPARSUN	.60
274-BJ	3-Gang Jack "	STANPARSIN	.60
*274-CP	4-Gang Plug "	STANPARSUM	.60
*274-CJ	4-Gang Jack "	STANPARGIN	.60
*274-EP	4-Gang Transformer Mounting Plug Base	STANPARGAS	.75
*274-EJ	4-Gang Transformer Mounting Jack Base	STANPARFAD	.75
†274-HP	6-Gang Transformer Mounting Plug Base	STANPARBED	.90
†274-HJ	6-Gang Transformer Mounting Jack Base	STANPARNOT	.90
274-Q	Locating Pin	STANPARCAD	.05

* Drilled to accommodate two more TYPES 274-P Plugs and 274-J Jacks for converting 4-gang bases into 6-gang bases. TYPE 274-Q Locating Pins for preventing insertion of jack bases in wrong position are supplied, although the illustration does not show them.

† Added to line after illustrations were prepared. Locating pins supplied.

BINDING-POST ASSEMBLIES			
Type	Description	Code Word	Price
274-K	With Type 138-V Binding Posts	STANPARBAG	\$0.65
274-L	" Type 138-X " "	STANPARTAG	.65

TYPE 274-RJ MOUNTING BASE

The new TYPE 274-RJ Mounting Base has been designed particularly for use with the TYPE 492-A Oxide Rectifier and the TYPE 493 Thermocouples described on page 42. The jacks are placed so that the TYPE 274-CP Transformer Mounting Base may be used with it.

The new base is made of moulded bakelite, is fitted with four jacks and four jack-top binding posts, and is drilled to accommodate a locating pin. Two countersunk screw holes are provided.

Dimensions: Size of base, exclusive of binding posts, $3\frac{3}{4} \times 1\frac{1}{2} \times \frac{5}{8}$ inches.

Type	Code Word	Price
274-RJ	STANPARPUP	\$1.00

NOTE: Locating pins now supplied with Type 274-CJ and Type 274-EJ.
 (ONE-HALF SCALE)

TRANSFORMER MOUNTING BASES

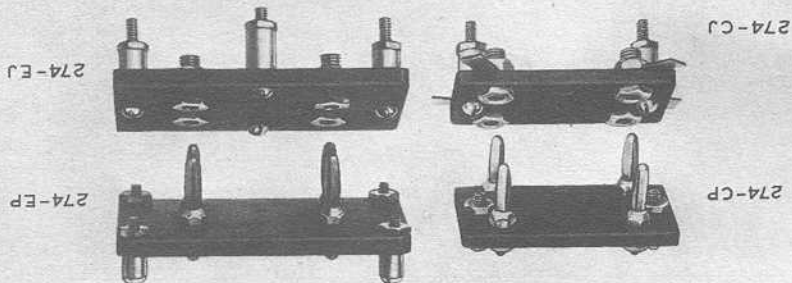

MOUNTING BASES

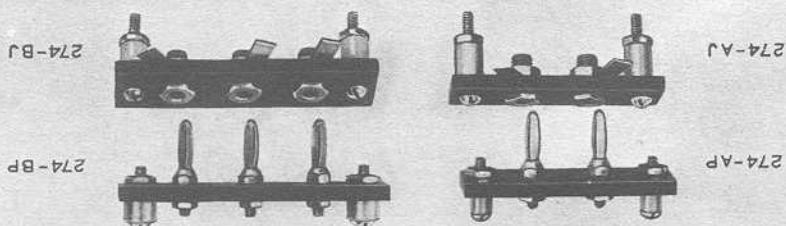

BINDING POST ASSEMBLIES

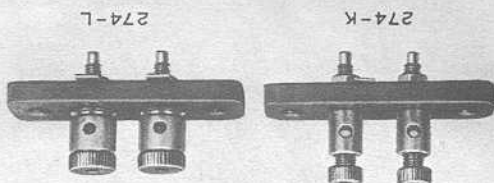

JACKS

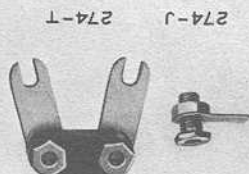

PLUGS

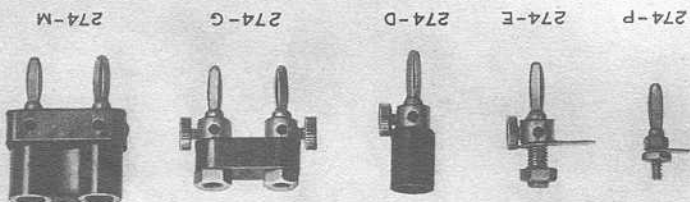

INDEX BY TYPE NUMBER

<i>Type</i>	<i>Instrument</i>	<i>Page</i>	<i>Type</i>	<i>Instrument</i>	<i>Page</i>
127	Hot-Wire Meters.....	36, 37	387-A	Speaker Filter.....	21
137	Knobs.....	48	404	Test-Signal Generator.....	29, 30
138	Binding Posts, Switch Contacts, and Stops.....	48	410	Rheostats and Potentiometers.....	13
139	Switch.....	50	426-A	Thermionic Voltmeter.....	33, 34
156	Socket.....	51	427-F	A. C. Voltmeter.....	34, 35
166	Telephone Transformer.....	21	437	Center-Tap Resistance.....	24
202	Switch.....	50	438	Socket.....	51
213	Audio Oscillator.....	16	439	Center-Tap Resistance.....	24
214	Rheostats and Potentiometers.....	11, 12	443	Mutual-Conductance Meter.....	32
240	Capacity Meter.....	31	446	Voltage Divider.....	23
241	Microphone Hummer.....	16	481	Polar Relay.....	44
247	Variable Air Condenser.....	3, 4	486	Output Meter.....	39
260	Porcelain Insulator.....	53	488-A	A. C. Voltmeter.....	35
268	Variocoupler.....	14	492-A	Oxide Rectifier.....	42, 43
269	Variometer.....	14	493	Thermocouples.....	43
274	Plugs, Jacks, and Bases.....	54	502	Dial.....	46
274-RJ	Mounting Base.....	54	503	Dial.....	46
276-A	Quartz Plate.....	26	507	Non-Polar Relay.....	44
280	Porcelain Insulator.....	53	527-A	Rectifier Filter.....	23
285	Amplifier Transformer.....	17	540	Filament Transformer.....	22
287	Direct-Reading Ohmmeter.....	37, 38	541	Push-Pull Transformer.....	20
301	Rheostats and Potentiometers.....	12, 13	545	Transformer.....	22
309	Socket Cushion.....	51	552	Volume Control.....	8
310	Dial.....	45	553	Volume Control.....	10
317	Dial.....	45	556	Amateur-Band Condenser.....	6
318	Dial Plate.....	45	557	Amateur-Band Condenser.....	6
334	Variable Air Condenser.....	4, 5	558-P	Frequency Meter.....	25
335-Z	Variable Air Condenser.....	5	565	Transformer.....	22
337	Switch.....	50	573-A	Resistance-Impedance Coupler.....	19
339	Switch.....	50, 51	577	Inductors.....	15
349	Socket.....	51	585	Amplifier Transformer.....	17-19
356	Quartz-Plate Holder.....	26	586	Power-Level Indicator.....	38-41
358	Wavemeter.....	26	586-P	Accessories.....	41
359	Variable-Ratio Transformer.....	20, 21	587	Speaker Filter.....	21
360-A	Test Oscillator.....	28	598-A	Fader.....	8
366	Filter Choke.....	23	638	Socket.....	52
368	Variable Air Condenser.....	6	638-P1	Socket-Mounting Ring.....	52
371	Potentiometers.....	11	649	Socket.....	52
374	Variable Air Condenser.....	5	656	Socket.....	52, 53
379	Radio-Frequency Chokes.....	24	657	Socket.....	52, 53
			658	Socket.....	52, 53

INDEX BY TITLE

<p>Air condensers, see <i>Condensers</i></p> <p>Ammeters, hot-wire, 36-37</p> <p>Amplifier, coupling devices, 17-21 transformers, 17-20</p> <p>Anti-capacity switches, 50-51</p> <p>Assemblies, binding-post, 54</p> <p>Audio oscillator, 16</p> <p>Bases, mounting, 54</p> <p>Binding posts, 48</p> <p>Binding-post assemblies, 54</p> <p>Bridge, capacity, 31 mutual-conductance, 32 vacuum-tube, 32</p> <p>Calibrated condensers, 3</p>	<p>Capacitance, see <i>Capacity</i></p> <p>Capacitors, see <i>Condensers</i></p> <p>Capacity bridges, 31 meter, 31</p> <p>Center-tap resistors, 24</p> <p>Choke, filter, 23 radio-frequency, 24</p> <p>Condensers, amateur-band, 6 calibrated, 3 high-voltage, 4-5 micro, 6 variable air, 3-6 vernier, 6</p> <p>Contacts, switch, 48</p>
--	--

INDEX BY TITLE

- Control, volume, 7-10
- Copper-oxide-rectifier voltmeter, 34-35, 38-42
- Coupler, resistance-impedance, 19
- Coupling devices, 17-21
- Cushion, socket, 51
- Dial plate, 45
- Dials, geared, 46
 - plain, 45
 - vernier, 46
- Divider, voltage, 7-13, 23
- Experimental inductors, 14-15
 - wavemeters, 25-26
- Fader, 8-10
- Filament transformer, 22
- Filter choke, 23
 - rectifier, 23
 - speaker, 21
- Frequency meter, amateur-band, 25
 - see *Wavemeter*
- Galvanometer, hot-wire, 36-37
- Geared dials, 46
- Generator, test-signal, 29-30
 - see *Oscillators*
- Holder, quartz-plate, 26
- Hot-wire meters, 36-37
- Hum-balancing resistors, 24
- Hummer, microphone, 16
- Impedance-resistance coupler, 19
- Inductors, 14-15
 - fixed, 15
 - variable, 14
- Insulators, porcelain, 53
- Jacks, 54
- Knobs, moulded, 48
- Meters, ammeters, 36-38
 - capacity, 31
 - frequency, see *Wavemeters*
 - hot-wire, 36-37
 - mutual-conductance, 32
 - ohmmeters, 37-38
 - output, 38-41
 - power-level indicators, 39-41
 - voltmeters, 33-35, 39-41
 - wave, 25-26
- Microphone hummer, 16
 - mixing controls, 7-13
 - transformer, 18
- Mixing controls, 7-13
- Moulded knobs, 48
- Mounting bases, 54
- Mutual-conductance meter, 32
- Non-polar relay, 44
- Ohmmeters, 37-38
- Oscillators, audio, 16
 - microphone-button, 16
 - microphone-hummer, 16
 - piezo-electric, 26
 - reed-type, 16
 - test, 27-28
 - test-signal, 29-30
 - tuning-fork, 16
- Output meter, 38-41
- Oxide rectifier, 42
 - voltmeters, 34-35, 39-42
- Plate, quartz, 26
- Plugs, 54
- Polar relay, 44
- Porcelain insulators, 53
- Portable capacity bridges, 31
- Potentiometers, 7-8, 10-13, 23
- Power-level indicator, 39-41
- Push-pull transformers, 20
- Quartz plate, 26
 - plate-holder, 26
- Radio-frequency chokes, 24
- Rectifier filter, 23
- Relay, low-current, 44
 - non-polar, 44
 - polar, 44
- Resistance-impedance coupler, 19
 - unit, center-tap, 24
- Rheostats, 10-13
- Service-testing equipment, 27-32
- Socket, 52
 - cushion, 51
 - mounting ring, 52
 - vacuum-tube, 51-53
- Speaker filters, 21
- Strain insulators, 53
- Switch contacts, 48
 - stops, 48
- Switches, 50
- Telephone transformer, 21
- Test oscillator, 27-28
 - signal generator, 29-30
- Thermionic voltmeter, 33-34
- Thermocouples, 43
- Transformers, amplifier, 17-20
 - filament-heating, 22
 - mounting bases, 54
 - plate-supply, 22
 - power-supply, 22
 - push-pull, 20
 - telephone, 21
- Transformers
 - variable-ratio, 20-21
- Tube, vacuum, bridge, 32
- Vacuum-tube bridge, 32
 - voltmeter, 33-34
- Variable air condensers, 3-6
 - inductors, 14
 - ratio transformer, 20-21
- Variocoupler, 14
- Variometer, 14
- Vernier condenser, 6
 - dial, 46
- Voltage divider, 7-8, 10-13, 23
- Voltmeter, oxide-rectifier, 34-35, 39-42
 - thermionic, 33-34
 - vacuum-tube, 33-34
- Volume controls, 7-13
- Wall insulators, 53
- Wavemeter, experimental, 25-26



GENERAL RADIO COMPANY

CAMBRIDGE A, MASSACHUSETTS

Pacific Coast Warehouse: 274 BRANNAN STREET : SAN FRANCISCO

CONDENSERS FOR FIVE-METER WORK

TYPE 568 VARIABLE AIR CONDENSERS

THESE are condensers of rugged construction for use as tuning elements in short-wave receivers, transmitters, and wavemeters. They are designed for tandem mounting, a hollow shaft permitting the use of a single long bakelite or metal shaft for driving several units. The isolantite end plates help to keep the losses at a minimum, a particularly important feature when working at 5 meters.

Range:

Two sizes are available. See the price list.

Rotor Plates:

Straight-line capacitance for the TYPE 568-D and straight-line frequency for the TYPE 568-K Variable Air Condensers.

Insulation:

Isolantite end plates.

Maximum Voltage:

500 volts, peak.

Figure of Merit:

$R\omega C^2 = 0.03 \times 10^{-12}$ based on measurements at 1000 cps.

Drive:

The rotor is attached to a hollow shaft through which a $\frac{3}{8}$ -inch insulating or conducting shaft may be slipped and fastened with two set screws. This permits driving several units which have been mounted in tandem with the same shaft. Bakelite shaft extending a maximum of $1\frac{5}{8}$ inches from rear face of mounting panel is supplied with each condenser.

Mounting:

Three tapped inserts attached to one end plate on a $\frac{7}{8}$ -inch radius are provided for mounting the condenser on a panel of any

thickness between $\frac{1}{8}$ and $\frac{5}{16}$ inch. Drilling template and three flat head machine screws are furnished.

Dimensions:

Panel space, $2\frac{1}{4} \times 2\frac{5}{8}$ inches required. Overall depth behind panel (exclusive of the shaft), $2\frac{3}{4}$ inches.

Weight:

$\frac{3}{4}$ pound.

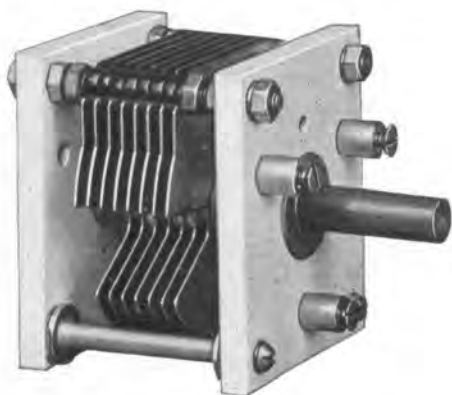

A TYPE 568-D Variable Air Condenser. Note the isolantite end plates and the removable bakelite shaft

Type	Capacitance		Plate Shape	Rotation Angle	Code Word	Price
	Maximum	Minimum				
568-D	175 $\mu\mu\text{f}$	12 $\mu\mu\text{f}$	SLC	180°	CLOVE	\$4.00
568-K	50 $\mu\mu\text{f}$	12 $\mu\mu\text{f}$	SLF	270°	CLOUD	4.00

WE PREPAY POSTAGE IN U.S. OR CANADA
IF PAYMENT ACCOMPANIES ORDER

GENERAL RADIO® COMPANY

CLASS B MODULATION TRANSFORMERS

TYPE 292 TRANSFORMERS

A Class B modulation system is ideal for the amateur, combining as it does good quality with a minimum of tubes and other equipment. Complete descriptions of the theory and operation of this system appear in *QST* for November and December, 1931.



TYPE 292-A

TYPE 292-B

Transformers

TYPE 292 Transformers are intended for use in the input and output circuits of a Class B modulation stage utilizing two 210-type tubes. TYPE 292-A is used for input; TYPE 292-B is used for output. Both units have been designed to work together and secure the best possible frequency characteristic.

Another important consideration is the high values of surge voltage that the output transformers must withstand. Both the TYPE 292-A and TYPE 292-B Transformers are tested on 4000 volts direct current between windings and between winding and core.

Both transformers are of General Radio quality, made with the best materials and workmanship. Like other General Radio transformers they are designed to have good electrical characteristics.

The TYPE 292-A Transformer is mounted in a Model B Case (see *Bulletin 933*, Pages 18 and 19) and weighs $27\frac{1}{8}$ pounds. The TYPE 292-B Transformer is mounted in a Model C Case (See Pages 18 and 19 of *Bulletin 933*) and weighs $4\frac{7}{8}$ pounds.

Type	Use	Code Word	Price
292-A	Class B Input	TUNIC	\$7.00
292-B	Class B Output	TUDOR	\$10.00

DIALS

The TYPE 317-A, TYPE 317-F, TYPE 503-A, and TYPE 503-F Dials described on Pages 45, 46, and 47 of *Bulletin 933* are now made with 100 divisions instead of 200 divisions as formerly. The dials affected by this change are those 4 inches in diameter which are graduated over 180° of their circumference.

WE SHIP WITHIN 24 HOURS AFTER RECEIVING YOUR ORDER